



## INSTRUCTION MANUAL

# VHF/UHF DIGITAL TRANSCEIVER ID-880H

This device complies with Part 15 of the FCC Rules. Operation is subject to the following two conditions: (1) this device may not cause harmful interference, and (2) this device must accept any interference received, including interference that may cause undesired operation.

**WARNING:** MODIFICATION OF THIS DEVICE TO RECEIVE CELLULAR RADIOTELEPHONE SERVICE SIGNALS IS PROHIBITED UNDER FCC RULES AND FEDERAL LAW.



**Icom Inc.**

---

## FOREWORD

---

Thank you for purchasing this fine Icom product. The ID-880H VHF/UHF DIGITAL TRANSCEIVER is designed with Icom's superior technology and craftsmanship combining traditional analog technologies with the new digital technology, Digital Smart Technologies for Amateur Radio (D-STAR), for a balanced package.

With proper care, this product should provide you with years of trouble-free operation. We want to take a couple of moments of your time to thank you for making your ID-880H your radio of choice, and hope you agree with Icom's philosophy of "technology first." Many hours of research and development went into the design of your ID-880H.

---

## EXPLICIT DEFINITIONS

---

WORD	DEFINITION
⚠ <b>WARNING!</b>	Personal injury, fire hazard or electric shock may occur.
<b>CAUTION</b>	Equipment damage may occur.
<b>NOTE</b>	Recommended for optimum use. No risk of personal injury, fire or electric shock.

---

## FEATURES

---

- *DV mode (digital voice + low-speed data communication) operation-ready*
  - *Text message and call sign exchange*
  - *Transmitting position data with a third-party GPS receiver*
- *DR (D-STAR Repeater) mode and repeater list allow you to operate a D-STAR repeater simply*
- *Switchable VHF and UHF transceiver*
- *50 W\*—high transmit output power*
  - \*Other than TPE version, TPE version: 25 W
- *Detachable controller for flexible installation*
- *Large tuning dial and band switch button*

---

## IMPORTANT

---

**READ ALL INSTRUCTIONS** carefully and completely before using the transceiver.

**SAVE THIS INSTRUCTION MANUAL—** This instruction manual contains important operating instructions for the ID-880H.

---

## PRECAUTIONS

---

**⚠ WARNING RF EXPOSURE!** This device emits Radio Frequency (RF) energy. Extreme caution should be observed when operating this device. If you have any questions regarding RF exposure and safety standards please refer to the Federal Communications Commission Office of Engineering and Technology's report on Evaluating Compliance with FCC Guidelines for Human Radio frequency Electromagnetic Fields (OET Bulletin 65).

**⚠ WARNING! NEVER** connect the transceiver to an AC outlet. This may pose a fire hazard or result in an electric shock.

**⚠ WARNING! NEVER** operate the transceiver while driving a vehicle. Safe driving requires your full attention—anything less may result in an accident.

**⚠ WARNING! NEVER** cut the DC power cable between the DC plug and fuse holder. If an incorrect connection is made after cutting, the transceiver may be damaged.

**NEVER** connect the transceiver to a power source of more than 16 V DC. This will damage the transceiver.

**NEVER** connect the transceiver to a power source using reverse polarity. This will damage the transceiver.

**NEVER** expose the transceiver to rain, snow or any liquids. The transceiver may be damaged.

**NEVER** operate or touch the transceiver with wet hands. This may result in an electric shock or damage the transceiver.

**NEVER** place the transceiver where normal operation of the vehicle may be hindered or where it could cause bodily injury.

**NEVER** let objects impede the operation of the cooling fan on the rear panel.

**DO NOT** push the PTT unless you actually intend to transmit.

**DO NOT** allow children to play with any radio equipment containing a transmitter.

During mobile operation, **DO NOT** operate the transceiver without running the vehicle's engine. When the transceiver's power is ON and your vehicle's engine is OFF, the vehicle's battery will soon become exhausted.

**DO NOT** use or place the transceiver in direct sunlight or in areas with temperatures below  $-10^{\circ}\text{C}$  ( $+14^{\circ}\text{F}$ ) or above  $+60^{\circ}\text{C}$  ( $+140^{\circ}\text{F}$ ).

**BE CAREFUL!** The transceiver will become hot when operating it continuously for long periods.

**DO NOT** set the transceiver in a place without adequate ventilation. Heat dissipation may be affected, and the transceiver may be damaged.

**DO NOT** use harsh solvents such as benzene or alcohol to clean the radio, because they can damage the transceiver's surfaces.

**USE** Icom microphones only (supplied or optional). Other manufacturers' microphones have different pin assignments and may damage the transceiver if attached.

Icom, Icom Inc. and the Icom logo are registered trademarks of Icom Incorporated (Japan) in the United States, the United Kingdom, Germany, France, Spain, Russia and/or other countries.

Microsoft, Windows and Windows Vista are registered trademarks of Microsoft Corporation in the United States and/or other countries.

All other products or brands are registered trademarks or trademarks of their respective holders.

## FCC INFORMATION

### • FOR CLASS B UNINTENTIONAL RADIATORS:

This equipment has been tested and found to comply with the limits for a Class B digital device, pursuant to part 15 of the FCC Rules. These limits are designed to provide reasonable protection against harmful interference in a residential installation. This equipment generates, uses and can radiate radio frequency energy and, if not installed and used in accordance with the instructions, may cause harmful interference to radio communications. However, there is no guarantee that interference will not occur in a particular installation. If this equipment does cause harmful interference to radio or television reception, which can be determined by turning the equipment off and on, the user is encouraged to try to correct the interference by one or more of the following measures:

- Reorient or relocate the receiving antenna.
- Increase the separation between the equipment and receiver.
- Connect the equipment into an outlet on a circuit different from that to which the receiver is connected.
- Consult the dealer or an experienced radio/TV technician for help.

### *For U.S.A. only*

**CAUTION:** Changes or modifications to this device, not expressly approved by Icom Inc., could void your authority to operate this device under FCC regulations.

## SUPPLIED ACCESSORIES

The following accessories are supplied with the transceiver.

① DC power cable (3 m†; 9.8 ft†)	.....	1
② Separation cable (3.4 m†; 11.2 ft†)	.....	1
③ Microphone (HM-133)	.....	1
④ Fuse (20 A)	.....	1
⑤ Microphone hanger	.....	1
⑥ Mounting screws, nuts and washers	.....	1 set
⑦ Mobile mounting bracket	.....	1
⑧ Remote controller bracket	.....	1

†Approx.

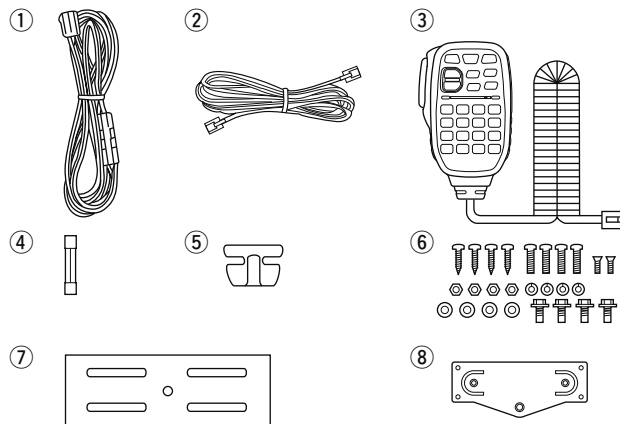

---

# TABLE OF CONTENTS

---

FOREWORD .....	i
EXPLICIT DEFINITIONS .....	i
FEATURES .....	i
IMPORTANT .....	i
PRECAUTIONS .....	ii
FCC INFORMATION .....	iii
SUPPLIED ACCESSORIES .....	iii
TABLE OF CONTENTS .....	iv–vi

## QUICK REFERENCE GUIDE ..... I–XI

■ Installation .....	I
■ Your first contact .....	VIII
■ Repeater operation .....	X
■ Programming memory channels .....	XI

## 1 PANEL DESCRIPTION ..... 1–10

■ Main unit .....	1
■ Front panel .....	2
■ Function display .....	4
■ Microphone (HM-133) .....	7
■ Microphone keypad .....	8
■ Optional microphone (HM-154) .....	10

## 2 BASIC OPERATION ..... 11–21

■ Preparation .....	11
■ Using the tuning dial .....	14
■ Using the [▲]/[▼] keys .....	14
■ Using the keypad .....	15
■ Tuning step selection .....	15
■ Lock functions .....	16
■ Receiving .....	17

■ Transmitting .....	17
■ Selecting output power .....	18
■ Operating mode selection .....	18
■ Squelch attenuator .....	19
■ Monitor function .....	20
■ Audio mute function .....	20
■ One-touch PTT function .....	21

## 3 REPEATER OPERATION ..... 22–28

■ General .....	22
■ Accessing a repeater .....	23
■ Subaudible tones (Encoder function) .....	25
■ Frequency offset .....	27
■ Auto repeater .....	28

## 4 DV MODE PROGRAMMING ..... 29–41

■ About the D-STAR system .....	29
■ Call sign programming .....	31
■ Repeater list .....	34
■ Repeater list programming .....	35
■ Changing a repeater list .....	40
■ Clearing a repeater list .....	41

## 5 DV MODE OPERATION ..... 42–72

■ Digital mode operation .....	42
■ Current call sign setting .....	42
■ Receiving a D-STAR repeater .....	43
■ Received call sign .....	44
■ Copying the call sign .....	46
■ DR (D-STAR Repeater) mode operation .....	48

<b>1</b>
<b>2</b>
<b>3</b>
<b>4</b>
<b>5</b>
<b>6</b>
<b>7</b>
<b>8</b>
<b>9</b>
<b>10</b>
<b>11</b>
<b>12</b>
<b>13</b>
<b>14</b>
<b>15</b>
<b>16</b>
<b>17</b>

---

# TABLE OF CONTENTS

---

■ Calling CQ .....	50	<b>8 SCAN OPERATION .....</b>	<b>100–110</b>
■ Calling a specific station .....	52	■ Scan types .....	100
■ Simplex operation in the VFO .....	56	■ Full/band/programmed scan .....	102
■ Repeater operation in the VFO .....	58	■ Scan edges programming .....	103
■ Message operation .....	64	■ Memory scan .....	105
■ Automatic reply function .....	66	■ Memory bank scan .....	106
■ EMR communication .....	67	■ Skip channel/frequency setting .....	108
■ Break-in communication .....	68	■ Scan resume condition .....	109
■ Low-speed data communication .....	70	<b>9 PRIORITY WATCH .....</b>	<b>111–115</b>
■ Other function in the DV mode .....	72	■ Priority watch types .....	111
<b>6 GPS/GPS-A OPERATION .....</b>	<b>73–86</b>	■ Priority watch operation .....	112
■ GPS operation .....	73	<b>10 MENU SCREEN OPERATION .....</b>	<b>116–141</b>
■ GPS-A operation .....	86	■ General .....	116
<b>7 MEMORY/CALL CHANNELS .....</b>	<b>87–99</b>	■ MENU screen indication and arrangement .....	118
■ General description .....	87	■ Items list .....	119
■ Selecting a memory channel .....	88	■ DUPT mode items .....	121
■ Selecting a call channel .....	89	■ SCAN mode items .....	123
■ Memory channel programming .....	90	■ SET mode — FUNC items .....	127
■ Memory bank setting .....	92	■ SET mode — DISP items .....	130
■ Memory bank selection .....	93	■ SET mode — SOUNDS items .....	132
■ Programming memory/bank/scan name .....	94	■ DV SET mode items .....	134
■ Selecting memory/bank name indication .....	95	■ GPS mode items .....	138
■ Copying memory/call contents .....	96	<b>11 DTMF MEMORY ENCODER .....</b>	<b>142–145</b>
■ Memory clearing .....	98	■ Programming a DTMF tone sequence .....	142
■ Erasing/transferring bank contents .....	99	■ Transmitting a DTMF tone sequence .....	143

---

# TABLE OF CONTENTS

---

■ DTMF speed .....	145
■ Clearing a DTMF memory .....	145
<b>12 TONE SQUELCH AND POCKET BEEP .....</b>	<b>146–152</b>
■ Tone/DTCS squelch (beep) operation .....	146
■ DTCS polarity setting .....	149
■ Tone scan .....	150
■ Digital squelch .....	151
<b>13 OTHER FUNCTIONS .....</b>	<b>153–163</b>
■ Microphone keys .....	153
■ All reset .....	154
■ Partial reset .....	154
■ Data cloning .....	155
■ Auto power OFF .....	157
■ Time-out timer .....	157
■ Packet operation .....	157
■ Weather channel operation .....	162
<b>14 MAINTENANCE .....</b>	<b>164–165</b>
■ Troubleshooting .....	164
■ Fuse replacement .....	165
<b>15 SPECIFICATIONS .....</b>	<b>166–167</b>
<b>16 OPTIONS .....</b>	<b>168</b>
<b>INDEX .....</b>	<b>169–175</b>

**1****2****3****4****5****6****7****8****9****10****11****12****13****14****15****16**

# QUICK REFERENCE GUIDE

## ■ Installation

### ◇ Precaution — magnets

#### ⚠ CAUTION

Magnets are used for the controller's attachment to a metal object.

**NEVER** attach the controller on the main unit's top cover, particularly around the internal speaker grill. It may cause the contents of the CPU and memory device to be deleted.

**NEVER** put the controller near a clock, television set (CRT type), magnetic compass or any magnetic/IC cards, credit cards, etc. The magnets may cause the products to malfunction or may erase the contents of magnetic storage devices.

Please note that the controller may detach and fall with impact or vibration.

### ◇ Installation methods

#### • *Single body installation*

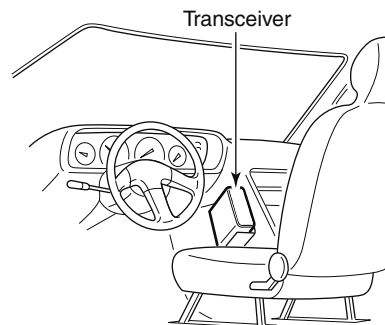

- The supplied mounting bracket can be used for the main unit installation.



• **Remote installation**

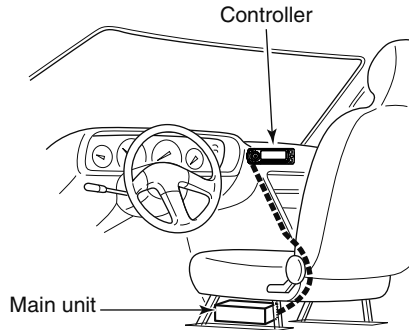

- The supplied remote controller bracket and separation cable can be used for installation.
- Optional OPC-440 MICROPHONE CABLE (5.0 m; 16.4 ft) and OPC-647 (2.5 m; 8.2 ft) are available to extend the microphone cable.
- Optional OPC-441 SPEAKER CABLE (5.0 m; 16.4 ft) is available to extend the speaker cable.

◇ **Location**

Select a location which can support the weight of the transceiver and does not interfere with driving. We recommend the locations shown in the diagram below.

**NEVER** place the transceiver or remote controller where normal operation of the vehicle may be hindered or where it could cause bodily injury.

**NEVER** place the transceiver or remote controller where air bag deployment may be obstructed.

**DO NOT** place the transceiver or remote controller where hot or cold air blows directly onto it.

**DO NOT** place the transceiver or remote controller in direct sunlight.

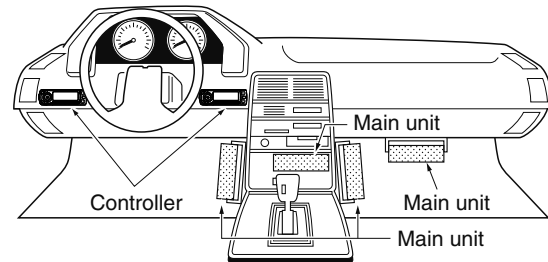

## QUICK REFERENCE GUIDE

### ◆ Using the mounting bracket

- ① Drill 4 holes where the mounting bracket is to be installed.
  - Approx. 5.5–6 mm (1/4") when using nuts; approx. 2–3 mm (1/8") when using self-tapping screws.
- ② Insert the supplied screws, nuts and washers through the mounting bracket and tighten.
- ③ Adjust the angle for your suitable position.

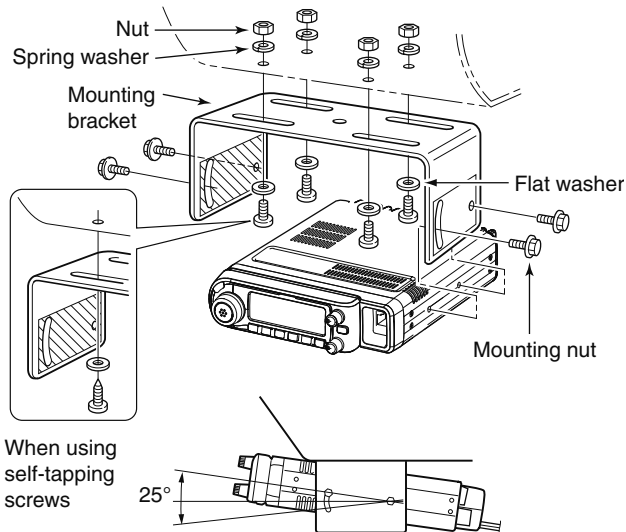

### ◆ Microphone connection

A microphone connector is available on the main unit front panel. Connect the supplied microphone connector as illustrated below.

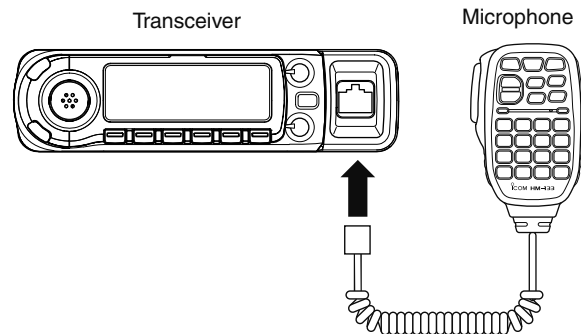

◇ **Controller's attachment/detachment**

You can attach or detach the controller to/from the main unit as below.

• **Attach the controller**

- ➔ Slide the controller in the direction of the arrow until the controller is locked and makes a 'click' sound.

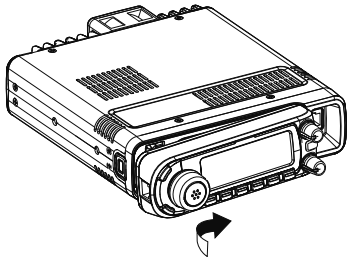

• **Detach the controller**

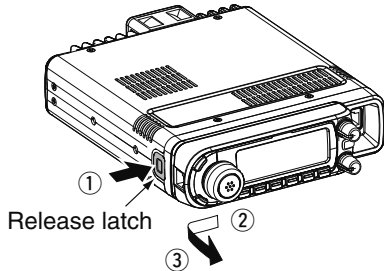

◇ **Separation cable connection**

Using the supplied separation cable (3.4 m; 11.2 ft), the controller can be separated from the main unit, doubling as a remote controller.

Connect the controller and the main unit using with the supplied separation cable as follows.

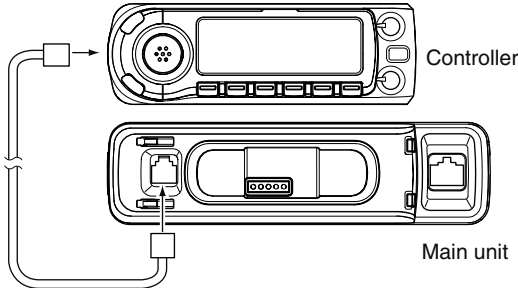

**CAUTION:**  
**NEVER** short the terminals of the single mount connectors for main unit or controller during separate operation. This will cause a transceiver malfunction or damage the transceiver.

## QUICK REFERENCE GUIDE

### ◇ Remote installation

The supplied remote controller bracket is used for remote installation.

These screws are not supplied.

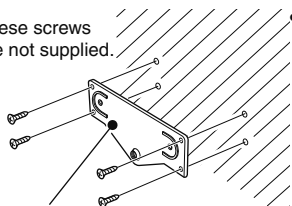

• Attach the remote controller bracket onto a flat surface using with 4 self-tapping screws (2.6 mm(d)), or double-sticky tape, etc., as at left, then attach remote controller to the bracket.

#### Remote controller bracket

#### When installing into your vehicle

① Remove two screws and magnets from the remote controller.

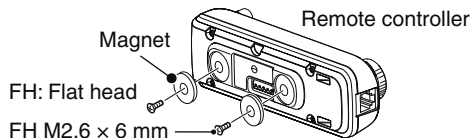

**CAUTION: NEVER** use any other than the supplied screws (FH M2.6 x 6 mm) if re-attaching the magnets to the remote controller. Otherwise the transceiver's internal board may be damaged.

② Attach the removed magnets to the remote controller bracket.

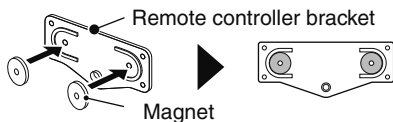

③ Attach the supplied remote controller bracket as below.

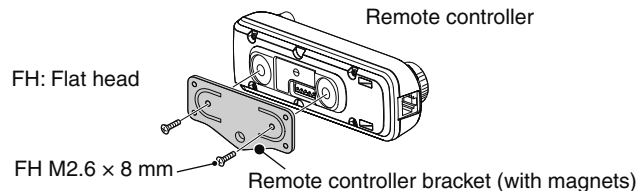

**CAUTION: NEVER** use any other than the supplied screws (FH M2.6 x 8 mm) for attaching the remote controller bracket. Otherwise the transceiver's internal board may be damaged.

④ Attach the remote controller on to the optional MB-120 as below.

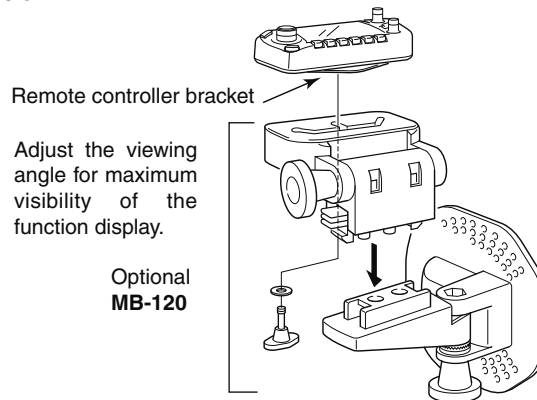

◇ **Battery connection**

- ➔ ⚠ **WARNING NEVER** remove the fuse holders from the DC power cable.
- ➔ **NEVER** connect the transceiver directly to a 24 V battery.
- ➔ **DO NOT** use the cigarette lighter socket for power connections. (See p. 1 for details)

Use a rubber grommet when passing the DC power cable through a metal plate to prevent a short circuit.

• **CONNECTING TO A DC POWER SOURCE**

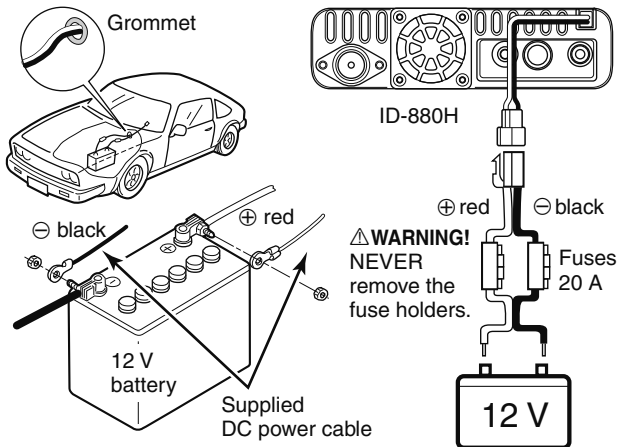

**NOTE:**  
Use terminals for the  
cable connections.

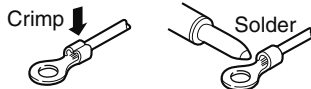

◇ **DC power supply connection**

Use a 13.8 V DC power supply with at least 15 A capacity.

Make sure the ground terminal of the DC power supply is grounded.

• **CONNECTING TO A DC POWER SUPPLY**

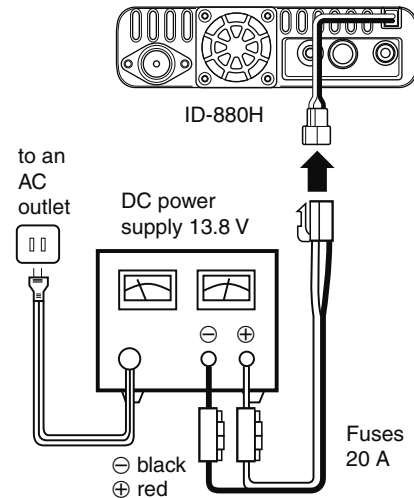

See p. 165 for fuse replacement.

## QUICK REFERENCE GUIDE

### ◇ Antenna installation

#### • Antenna location

To obtain maximum performance from the transceiver, select a high-quality antenna and mount it in a good location. It is not necessary to use radials on a magnetic mount ("mag mount") antenna.

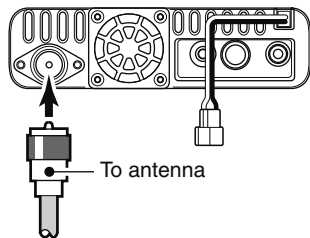
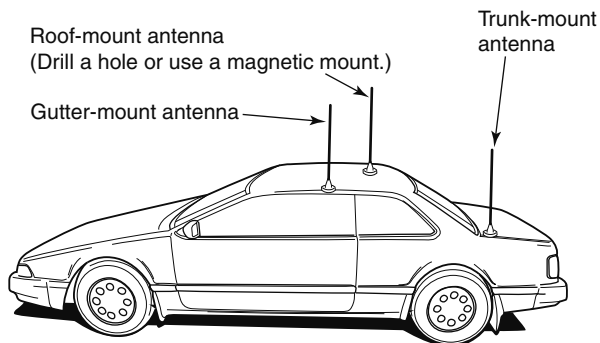

#### • Antenna connector

The antenna uses a PL-259 connector.

#### • PL-259 CONNECTOR

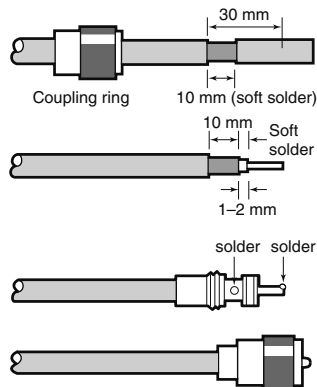

① Slide the coupling ring down. Strip the cable jacket and tin.

② Strip the cable as shown at left. Soft solder the center conductor.

③ Slide the connector body on and solder it.

④ Screw the coupling ring onto the connector body.

(10 mm  $\cong$  3/8 in)

**NOTE:** There are many publications covering proper antennas and their installation. Check with your local dealer for more information and recommendations.

# ■ Your first contact

Now that you have your ID-880H installed in your car or shack, you are probably anxious to get on the air. We would like to take you through a few basic operation steps to make your first time “On The Air” an enjoyable experience.

## 1. Turning ON the transceiver

Before powering up your ID-880H, you may want to make sure the audio volume and squelch level controls are set in 9–10 o'clock positions.



Although you have purchased a brand new transceiver, some settings may be changed from the factory defaults because of the Quality Control (QC) process. Resetting the CPU is necessary to start from factory default.

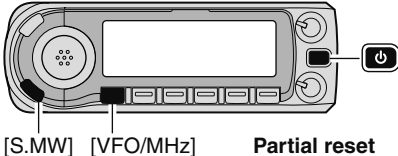

➔ While pushing and holding [S.MW] and [VFO/MHz] keys, push and hold [POWER] for 1 sec. to reset the CPU.

## 2. Selecting the operating frequency band

The ID-880H can use the 2 m or 70 cm amateur bands.

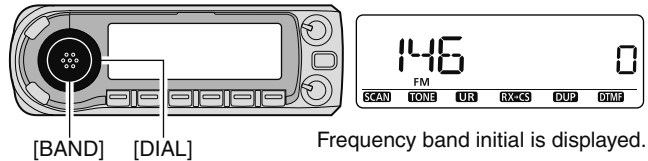

- ➔ Push [BAND] then rotate [DIAL] to select the desired frequency band.
- Push [BAND] again to return to the frequency indication.

## Using the HM-133

You can select the desired frequency band from the HM-133.

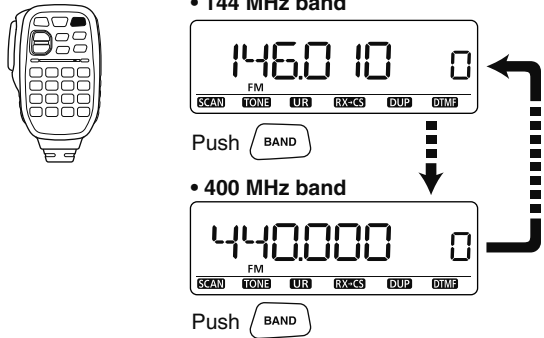

QUICK REFERENCE

---

## QUICK REFERENCE GUIDE

### 3. Tune the frequency

The tuning dial will allow you to dial in the frequency you want to use. Page 15 will instruct you on how to set the tuning speed.

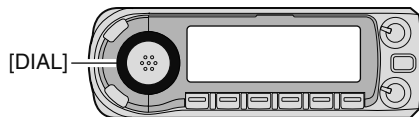

Rotate [DIAL] to tune the frequency.

---

### Using the HM-133

You can directly enter the frequency with the HM-133 keypad.

**[EXAMPLE]:** Setting frequency to 145.3625 MHz.

Push **VFO/LOCK**

145680	0
FM	
SCAN TONE UR RX-CS DUP DTMF	

Push **T-OFF ENT C**

.	0
FM	
SCAN TONE UR RX-CS DUP DTMF	

Push **BANK MONI1** **DTCS HIGH4** **DTCS MID 5**

145.36	0
FM	
SCAN TONE UR RX-CS DUP DTMF	

Push **PTT-M PRIO3** **DTMF LOW 6**

145.36	0
FM	
SCAN TONE UR RX-CS DUP DTMF	

Push **T-SCAN SCAN2**

145.3625 <sup>50</sup>	0
FM	
SCAN TONE UR RX-CS DUP DTMF	



## ■ Repeater operation

### 1. Setting duplex

- ➔ Push **[BAND]** then rotate **[DIAL]** to select the frequency band.
- ➔ Push **[BAND]** again, then rotate **[DIAL]** to select the repeater frequency.
- ➔ Push and hold **[DUP]**(LOW) for 1 sec. then rotate **[DIAL]** to select minus duplex or plus duplex.  
Push **[DUP]**(LOW) again.
  - The USA and Korean versions have an auto repeater function, therefore, setting duplex is not required.

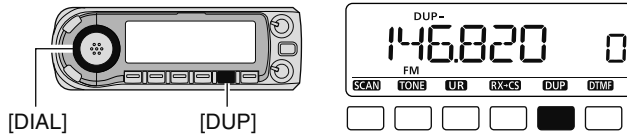

### 2. Repeater tone

Push and hold **[TONE]**(M/CALL) for 1 sec. then rotate **[DIAL]** to select "TONE," if the repeater requires a subaudible tone to be accessed. Push **[TONE]**(M/CALL) again.

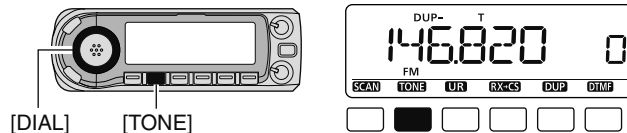

### Using the HM-133

Plus or minus duplex selection and the repeater tone setting can be done easily via the HM-133.

Push **[DUP- 7(TONE)]** for minus duplex; **[DUP+ 8(TSQL ((•)))]** for plus duplex selection, push **[FUNC]** then **[DUP- 7(TONE)]** to turn the repeater tone ON.

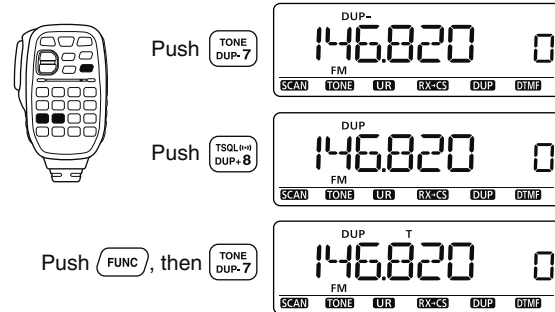

### ■ Programming memory channels

The ID-880H has a total of 1052 memory channels (including 25 pairs scan edges and 2 call channels) for storing often-used operating frequency, repeater settings, etc.

#### 1. Setting a frequency

In the VFO mode, set the desired operating frequency with repeater, tone and tuning steps, etc.

- ➔ Push [VFO/MHz] to select the VFO.
- ➔ Rotate [DIAL] to set the desired frequency.
  - Set other data, such as repeater tone, duplex information, tuning step), if desired.

#### 2. Selecting a memory channel

Push [S.MW], then rotate [DIAL] to select the desired memory channel.

- “MR” indicator and memory channel number blink.

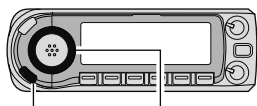

[S.MW] [DIAL]



CLR

#### 3. Writing a memory channel

Push and hold [MW](S.MW) for 1 sec. to program.

- 3 beeps sound.
- Return to the VFO mode automatically after programming.
- Memory channel number automatically increases when continuing to push [MW](S.MW) after programming.

#### Using the HM-133

- ① Push [MR/CALL] to select the memory mode.
- ② Push [ENT C(T-OFF)] first, then enter the desired memory channel via the keypad.
- ③ Push [VFO/LOCK] to select the VFO mode, then set the desired operating frequency, including offset direction, tone settings, etc.
  - ➔ Push [VFO/LOCK] to select the VFO.
  - ➔ Push [ENT C(T-OFF)] first, then enter the desired operating frequency via the keypad.
    - Set other data, such as repeater tone, duplex information, tuning step, if necessary.
- ④ Push [FUNC] then push and hold [CLR A(MW)] for 1 sec. to program.



Push [FUNC], then [MW CLR A]

- 3 beeps sound.
- Memory channel number automatically increases when continuing to push [CLR A(MW)] after programming.

## ■ Main unit

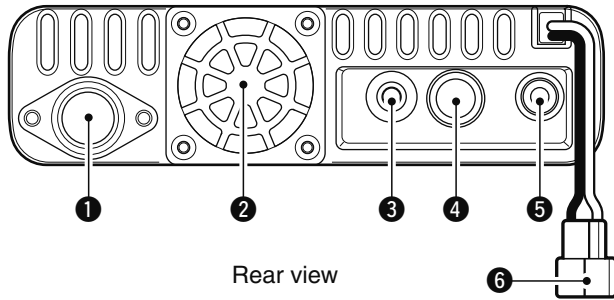

Rear view

- 1 ANTENNA CONNECTOR [ANT]** (p. VII)  
Connects a 50  $\Omega$  antenna with a PL-259 connector and a 50  $\Omega$  coaxial cable for transmission and reception.
- 2 COOLING FAN**  
Rotates while transmitting.  
Also rotates while receiving depending on the setting in the FUNC set mode (SET). (p. 129)
- 3 DATA JACK [DATA]**
  - ➔ Connect a PC through the optional data communication cable OPC-1529R, for low-speed data communication in the DV mode or data cloning with the cloning software CS-80/880 (free download). (pgs. 70, 156)
  - ➔ Connect a GPS receiver through the optional data communication cable OPC-1529R, for GPS operation. (p. 73)

- 4 PACKET JACK [PACKET]** (pgs. 157, 158)  
Connects a TNC (Terminal Node Controller), etc. for data communications. The transceiver can support 1200/9600 bps packet communication (AFSK/GMSK).

- 5 EXTERNAL SPEAKER JACK [SP]**
  - ➔ Connects an 8  $\Omega$  speaker.
    - Audio output power is more than 2.0 W.
  - ➔ Connect an optional cloning cable OPC-478/478UC or OPC-474 for data cloning. (pgs. 155, 156)

- 6 POWER RECEPTACLE [DC13.8V]**  
Accepts 13.8 V DC  $\pm 15\%$  with the supplied DC power cable.

**NOTE: DO NOT** use a cigarette lighter socket as a power source when operating in a vehicle. The plug may cause voltage drops and ignition noise may be superimposed onto transmit or receive audio.

### ANTENNA INFORMATION

For radio communications, the antenna is of critical importance, to maximize your output power and receiver sensitivity. The transceiver accepts a 50  $\Omega$  antenna and a Voltage Standing Wave Ratio (VSWR) of 1.5:1 or less. High SWR values not only may damage the transceiver but also lead to TVI or BCI problems.

# 1 PANEL DESCRIPTION

## ■ Front panel

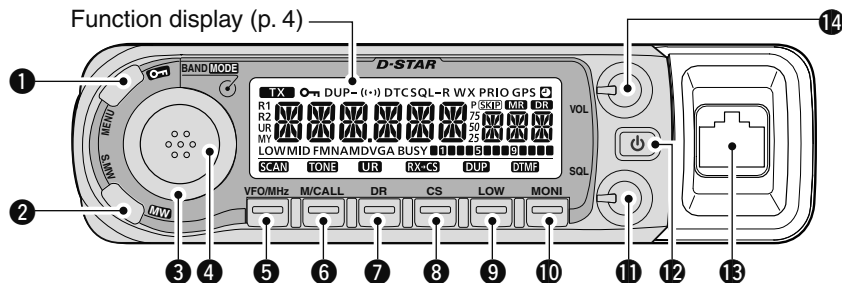

### 1 MENU-LOCK KEY [MENU]

- ➔ Push to enter the MENU screen indication ON or OFF. (p. 116)
- ➔ Push and hold for 1 sec. to toggle the lock function ON or OFF. (p. 16)

### 2 SELECT MEMORY WRITE-MEMORY WRITE KEY

[S.MW] (pgs. 90, 92, 94, 96–99, 103)

- ➔ Push to enter the select memory write mode for memory channel programming.
  - Push [MENU] to cancel and exit the select memory write mode.
- ➔ Push and hold to store the frequency, operating mode, etc. into the selected memory channel.

### 3 TUNING DIAL [DIAL]

Selects the operating frequency (p. 14), memory channel (pgs. 12, 88), the setting of the set mode item (p. 116) and the scanning direction (pgs. 102, 105, 106).

### 4 BAND-MODE KEY [BAND-MODE]

- ➔ Push to enter the band selection state. (p. 11)
  - Rotating [DIAL] selects the band.
- ➔ Push and hold for 1 sec. to enter operating mode selection state. (p. 18)
  - Rotating [DIAL] selects the operating mode.

### 5 VFO/MHz TUNING-SCAN KEY [VFO/MHz]

- ➔ Push to select the VFO mode. (p. 12)
- ➔ During VFO mode operation, push to select 1 MHz and 10 MHz tuning steps. (p. 14)
- ➔ Push and hold for 1 sec. to enter the scan type selection state. (pgs. 102, 105, 106, 150)
  - Cancels a scan when pushed during scan.

### 6 MEMORY/CALL-TONE KEY [M/CALL-TONE]

- ➔ Push to select memory, call and weather channel\* modes. (pgs. 12, 13, 88, 89, 162)

\*Weather channels are available depending on versions.

- ➔ During FM/FM-N mode operation, push and hold for 1 sec. to enter the tone function selection state. (pgs. 23, 146)
  - Rotating **[DIAL]** selects the tone function.
  - T (Repeater tone), TSQL (↵), TSQL, DTCS (↵), DTCS, tone squelch reverse, DTCS squelch reverse or tone function OFF can be selected.

- ➔ During DV mode operation, push and hold for 1 sec. to select the digital call sign squelch, digital code squelch and no digital squelch operation in sequence. (p. 151)
  - Rotating **[DIAL]** selects the digital squelch function.
  - DSQL (↵), DSQL, CSQL (↵), CSQL or digital call squelch OFF can be selected.

**7 DR (D-STAR REPEATER)•UR KEY [DR•UR]**

- ➔ Push to select the DR mode. (pgs. 13, 50, 52)
  - Rotating **[DIAL]** selects access repeater.
  - The DV mode is automatically selected when other mode is selected.
- ➔ During DV mode operation, push and hold for 1 sec. to enter UR call sign selection state. (pgs. 50, 52, 56–61)
  - Rotating **[DIAL]** selects UR call sign.
  - The DV mode is automatically selected when other mode is selected.

**8 CALL SIGN•RX CALL SIGN SET KEY [CS•RX→CS]**

During DV mode operation:

- ➔ Push to display the current call sign. (p. 43)
  - Rotating **[DIAL]** selects UR, R1 (access repeater), R2 (linked repeater) and MY (your own) call signs.
- ➔ Push and hold for 1 sec. to set the received call signs (Caller and RXRPT1/2) to the current call sign. (p. 45)
  - Only received caller call sign is displayed in the DR mode. (p. 55)

**9 OUTPUT POWER•DUPLEX KEY [LOW•DUP]**

- ➔ Each push changes the output power selection. (p. 18)
  - LOW, MID and HIGH (no indicator visible) are available.
- ➔ Push and hold for 1 sec. to enter the duplex operation selection state. (p. 23)
  - Rotating **[DIAL]** selects the duplex direction.
  - DUP– (minus duplex), DUP (plus duplex) and simplex (no indicator visible) are available.

**10 MONITOR•DTMF KEY [MONI•DTMF]**

- ➔ Push to turn the monitor function ON or OFF. (p. 20)
- ➔ Push and hold for 1 sec. to enter DTMF set screen. (p. 142)

**11 SQUELCH CONTROL [SQL]**

- Varies the squelch level. (p. VIII)
- The RF attenuator activates and increases the attenuation when rotated clockwise at beyond the center position. (p. 19)

**12 POWER KEY [PWR]** (pgs. VIII, 11)

Push and hold for 1 sec. to turn power ON or OFF.

**13 MICROPHONE CONNECTOR** (p. III)

Connects the supplied or an optional microphone.

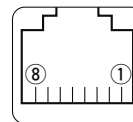

- |                                  |                              |
|----------------------------------|------------------------------|
| ① +8 V DC output<br>(Max. 10 mA) | ⑤ GND<br>(microphone ground) |
| ② Channel up/down                | ⑥ MIC<br>(microphone input)  |
| ③ 8 V control IN                 | ⑦ GND                        |
| ④ PTT                            | ⑧ Data IN                    |

**14 VOLUME CONTROL [VOL]** (p. VIII)

Adjusts the audio level.

# 1 PANEL DESCRIPTION

## ■ Function display

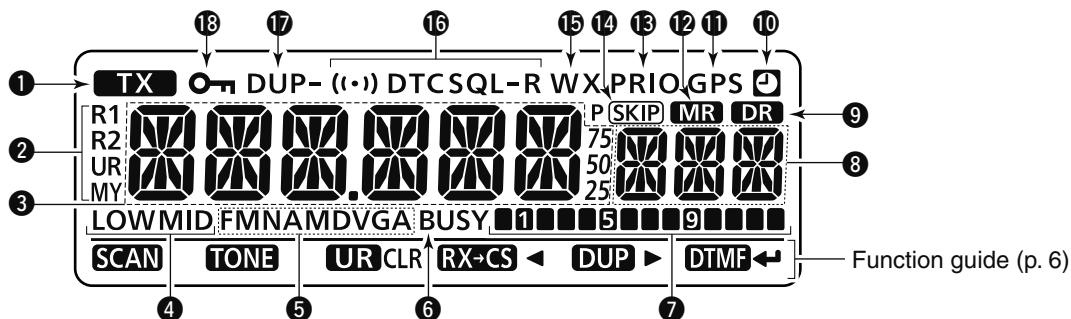

### 1 TRANSMIT INDICATOR

➔ Appears while transmitting. (p. 17)

### 2 CALL SIGN TYPE INDICATORS

“MY” appears when MY call sign is selected; “UR” appears when UR station call sign is selected; “R1” appears when access repeater call sign (RPT1) is selected; “R2” appears when linked repeater call sign (RPT2) is selected.

### 3 FREQUENCY READOUT

Shows the operating frequency, set mode contents, etc.  
• Frequency decimal point blinks while scanning. (p. 102, 105, 106)

### 4 OUTPUT POWER INDICATORS (p. 18)

“LOW” appears when low output power; “MID” appears when middle output power, no indication appears when high output power is selected.

### 5 OPERATING MODE INDICATOR (p. 18)

Shows the selected operating mode.

- FM, FMN (FM narrow), AM, NAM (AM narrow) and DV (Digital voice) are available.
- “DVG” or “DV A” appears when GPS transmission or GPS-A transmission is selected in the DV mode. (p. 138)

### 6 BUSY INDICATOR

- ➔ Appears when a signal is being received or the squelch is open. (p. 17)
- ➔ Blinks while the monitor function is activated. (p. 20)

### 7 S/R/F INDICATORS (p. 17)

- ➔ Shows the relative signal strength while receiving signals.
- ➔ Shows the output power level while transmitting. (p. 18)

**8 MEMORY CHANNEL NUMBER INDICATORS**

- Shows the selected memory channel number. (pgs. 12, 88)
- Shows the selected bank initial. (p. 93)
- “C0” or “C1” appears when the call channel is selected. (pgs. 13, 89)

**9 DR (D-STAR REPEATER) INDICATOR** (pgs. 13, 50, 52)  
Appears when the DR mode is selected.

**10 AUTO POWER OFF INDICATOR** (p. 130)  
Appears when the auto power OFF function is in use.

**11 GPS INDICATOR**  
Appears when a GPS receiver is connected and a valid position data is received; blinks when an invalid data is received.  
• GPS indicator can be turned OFF in GPS.SET mode. (p. 138).

**12 MEMORY INDICATOR** (pgs. 12, 88)  
Appears when the memory mode is selected.

**13 PRIORITY INDICATOR** (pgs. 112, 113, 115)  
Appears while priority watch is activated, blinks while priority watch is paused.

**14 SKIP INDICATOR** (p. 108)  
➤ “**SKIP**” appears when the displayed memory channel is specified as a skip channel.  
➤ “**P SKIP**” appears when the displayed frequency is specified as a program skip frequency.

**15 WEATHER ALERT INDICATOR** (p. 124, 162)  
“WX” appears when the weather alert function\* is in use.

\*Available depending on versions.

**16 TONE INDICATOR**

• ***During FM/FM-N mode operation:***

- “T” appears while the repeater tone is in use. (p. 23)
- “T SQL” appears while the tone squelch function is in use. (p. 146)
- “T SQL-R” appears while the reverse tone squelch function is in use. (p. 147)
- “DTCS” appears while the DTCS squelch function is in use. (p. 146)
- “DTCS -R” appears while the reverse DTCS squelch function is in use. (p. 147)
- “(·)” appears with the “T SQL” or “DTCS” indicator while the pocket beep function is in use. (p. 146)

• ***During DV mode operation:***

- “D SQL” appears while the digital call sign squelch function is in use. (p. 151)
- “CSQL” appears while the digital code squelch function is in use. (p. 151)
- “(·)” appears with the “D SQL” or “C SQL” indicator while the pocket beep function is in use. (p. 151)

**17 DUPLEX INDICATORS** (p. 23)

“DUP” appears when plus duplex, “DUP-” appears when minus duplex (repeater) operation is selected.

**18 KEY LOCK INDICATOR** (p. 16)

Appears when the key lock function is activated.

# 1 PANEL DESCRIPTION

## ◇ Function guide indicator

The function guides give you easy menu access to a variety of functions. Two function guides are available.

### • Secondary function guides

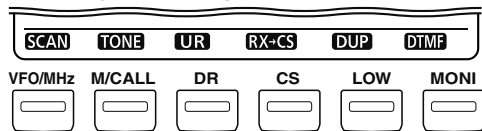

These function guides indicate the secondary functions for below the keys. Push and hold for 1 sec to activate the indicated functions. See page 2 to 3 (5 to 10).

### • Set condition guides

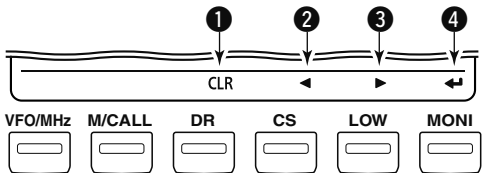

Set condition guides appear when the transceiver enters the MENU screen, select memory write state, etc.

### ① CLEAR KEY [CLR](DR)

- ➔ During programming state for call signs, repeater list, memory name, etc., push to erase the selected character. (pgs. 31, 33, 39, 40, 94)
- ➔ During programming state for call signs, repeater list, memory name, etc., push and hold for 1 sec. to erase all character following the cursor. (pgs. 31, 33, 37–40, 94)

### ② LEFT KEY [◀](CS)

- ➔ During programming state for call signs, repeater list, memory name, etc., push to move the cursor left. (pgs. 31–33, 35–40, 94)
- ➔ During MENU screen operation, push to select the upper layer. (p. 116)

### ③ RIGHT KEY [▶](LOW)

- ➔ During programming state for call signs, repeater list, memory name, etc., push to move the cursor right. (pgs. 31–33, 35–40, 94)
- ➔ During MENU screen operation, push to select the lower layer. (p. 116)

### ④ ENTER KEY [↵](MONI)

- ➔ During programming state for call signs, repeater list, etc., push to set or store the setting. (pgs. 31, 33, 35–40, 94)
- ➔ During MENU screen operation, push to enter or exit to/from the selected set items, etc. (p. 116)

/// **NOTE:** During set condition guide indication, [BAND] key is also used instead of [↵](MONI).



## Microphone (HM-133)

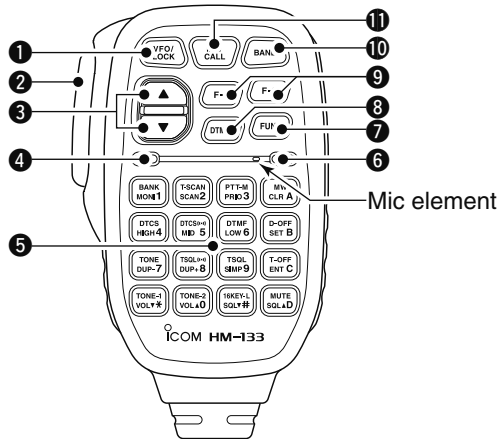

### 1 VFO/LOCK KEY [VFO/LOCK]

- ➔ Push to select the VFO mode. (p. 12)
- ➔ Push and hold for 1 sec. to turn the lock function ON or OFF. (p. 16)

### 2 PTT SWITCH

- ➔ Push and hold to transmit; release to receive.
- ➔ Switches between transmitting and receiving while the one-touch PTT function is in use. (p. 21)

### 3 UP/DOWN KEYS [▲]/[▼]

- ➔ Push either key to change operating frequency, memory channel, set mode setting, etc. (pgs. 12, 14, 88, 117)
- ➔ Push and hold either key for 1 sec. to start scanning. (p. 107)

### 4 ACTIVITY INDICATOR

- ➔ Lights red while any key, except [FUNC] and [DTMF-S], is pushed, or while transmitting.
- ➔ Lights green while the one-touch PTT function is in use. (p. 21)

### 5 KEYPAD (pgs. 8, 9)

### 6 FUNCTION INDICATOR

- ➔ Lights orange while [FUNC] is activated—indicates the secondary function of keys can be accessed.
- ➔ Lights green when [DTMF-S] is activated—DTMF signals can be transmitted with the keypad.

### 7 2nd FUNCTION KEY [FUNC]

### 8 DTMF SELECT KEY [DTMF-S] (p. 144)

### 9 FUNCTION KEYS [F-1]/[F-2] (p. 153)

- Program and recall your desired transceiver configuration.

### 10 BAND KEY [BAND] (p. 11)













- Push to select the operating bands.









### 11 MEMORY/CALL KEY [MR/CALL]

- ➔ Push to select the memory mode. (p. 88)
- ➔ Push and hold for 1 sec. to select call channel. (p. 89)

# 1 PANEL DESCRIPTION

## ■ Microphone keypad

KEY	FUNCTION	SECONDARY FUNCTION (  +key)	OTHER FUNCTIONS
	Switches between opening and closing the squelch. (p. 20)	In the VFO mode, selects the operating band. (p. 11) In the memory mode enters bank selection state. (p. 93)	After pushing  : Transmits the appropriate DTMF code. (pgs. 26, 144) When the DTMF memory encoder is activated, push [0] to [9] to transmit the appropriate DTMF memory contents. (p. 144)
	Starts and stops scanning. (p. 107)	Starts and stops tone scanning. (p. 150)	
	Starts and stops priority watch. (p. 114)	Turns the one-touch PTT function ON or OFF. (p. 21)	
	Selects high output power. (p. 18)	Turns the DTCS squelch ON. (p. 146)	
	Selects mid. output power. (p. 18)	Turns the DTCS pocket beep function ON. (p. 146)	
	Selects low output power. (p. 18)	Turns the DTMF memory encoder function ON. (p. 143)	
	Selects minus duplex operation. (p. 24)	Turns the subaudible tone encoder ON. (p. 25)	
	Selects plus duplex operation. (p. 24)	Turns the CTCSS pocket beep function ON. (p. 146)	
	Selects simplex operation. (p. 24)	Turns the tone squelch function ON. (p. 146)	
	Increases audio output level. (p. 17)	Sends a 1750 Hz tone signal while pushing and holding. (p. 26)	

KEY	FUNCTION	SECONDARY FUNCTION (  +key)	OTHER FUNCTIONS
	<ul style="list-style-type: none"> <li>➔ Cancels frequency entry. (p. 15)</li> <li>➔ Cancels the scan or priority watch. (pgs. 107, 114)</li> <li>➔ Exits the MENU screen. (p. 117)</li> </ul>	<ul style="list-style-type: none"> <li>➔ Stores the set frequency, etc., into the selected memory channel when pushed and held. (p. 91)</li> <li>➔ Advances the memory channel number when continuously pushed after programming is completed. (p. 91)</li> </ul>	After pushing  : Transmits the appropriate DTMF code. (pgs. 26, 144)
	<ul style="list-style-type: none"> <li>➔ Enters the MENU screen. (p. 117)</li> <li>➔ Enters selected set mode. (p. 117)</li> <li>➔ Enters programmable condition after selecting a set mode item. (p. 117)</li> </ul>	DTMF memory encoder function OFF. (p. 143)	
	<ul style="list-style-type: none"> <li>➔ Sets the keypad for numeral input. (p. 15)</li> <li>➔ Returns to the previous indication after entering set mode. (p. 117)</li> </ul>	Turns the subaudible tone encoder, pocket beep or CTCSS/DTCS tone squelch OFF. (pgs. 25, 146)	
	Adjusts the squelch level increments. (p. 17)	Mutes the audio. (p. 20) • Mute function is released when any operation is performed.	
	Decreases audio output level. (p. 17)	Sends a 1750 Hz tone signal for 0.5 sec. (p. 26)	
	Adjusts the squelch level decrement. (p. 17)	Locks the digit keys on the keypad (including the A to D, # and * keys. (p. 16)	

# 1 PANEL DESCRIPTION

## ■ Optional Microphone (HM-154)

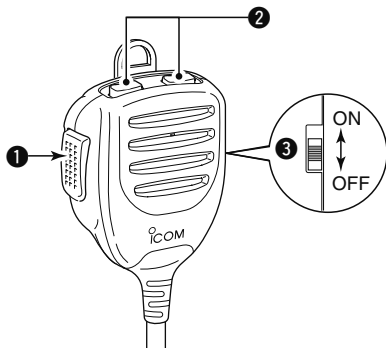

### ① PTT SWITCH

Push and hold to transmit; release to receive.

### ② UP/DOWN KEYS [UP]/[DN]

- Push either key to change operating frequency, memory channel, set mode setting, etc. (pgs. 12, 14, 88, 117)
- Push and hold either key for 1 sec. to start scanning. (p. 107)

### ③ UP/DN LOCK SWITCH

Slide to toggle [UP]/[DN] keys lock function ON or OFF.

Optional microphone (HM-103) is also available.

## ■ Preparation

### ◇ Turning power ON/OFF

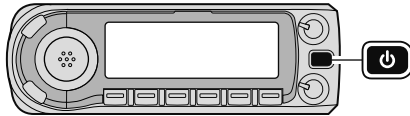

➔ Push and hold [POWER] for 1 sec. to turn power ON or OFF.

### ◇ Operating frequency band selection

The ID-880H has 2 m and 70 cm bands for transmission and reception. In addition, extra frequency bands 127, 220, 350, 500 and 900 MHz band are available for wide-band receiver capability (depending on versions, see p. 166 for details).

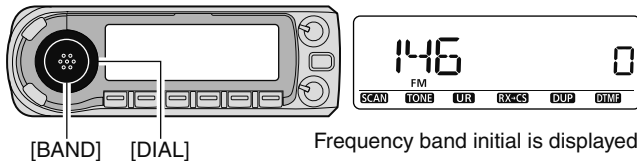

Frequency band initial is displayed.

- ① Push [BAND] and rotate [DIAL] to select the desired frequency band.
  - Pushing [▲]/[▼] on the microphone also selects the band.
- ② Push [BAND] to return to frequency indication in the selected frequency band.



➔ Push [BAND] several times to select the desired frequency band.



- ① Push [FUNC] then push [MONI 1(BANK)] to enter the frequency band selection.
  - The frequency band is displayed.

- ② Push [▲]/[▼] to select the desired frequency band.



- ③ Push [CLR A(MW)] to exit the state, and return to the frequency indication.



Note that in this manual, sections beginning with a microphone icon (as above), designate operation via the HM-133 microphone.

## 2 BASIC OPERATION

### ◇ VFO mode

VFO mode is used to set the desired frequency.

➡ Push **[VFO/MHz]** to select the VFO mode.

- When the VFO mode is already selected, the digits to the right of the 10 MHz will disappear. In this case, push **[VFO/MHz]** twice.

#### • VFO mode indication



[VFO/MHz]



VFO/LOCK

➡ Push **[VFO/LOCK]** to select the VFO mode.

#### What is VFO?

VFO is an abbreviation of Variable Frequency Oscillator. Frequencies for both transmitting and receiving are generated and controlled by the VFO.

### ◇ Memory mode

Memory mode is used for operation on the memory channels which store programmed frequencies.

① Push **[M/CALL]** to select the memory mode.

- Push **[M/CALL]** several times to select Memory/Call/Weather\* channels in sequence. \* Weather channels are selectable depending on versions.
- “**MR**” indicator appears when the memory mode is selected.

#### • Memory mode indication

Appears



[M/CALL]



② Rotate **[DIAL]** to select the desired memory channel.

- Only programmed memory channels can be selected.
- See p. 90 for memory programming details.



MR/CALL

- 1 Push **[MR/CALL]** to select the memory mode.
- 2 Push **[▲]** or **[▼]** to select the desired memory channel.

◇ Call/Weather\* channels

Call channels are used for quick recall of most-often used frequencies. \*Weather channels are available depending on versions.

- ① Push **[M/CALL]** several times to select call channels/Weather channels.
  - Memory/Call/Weather channels can be selected in sequence.
  - “CO” or “C1” appears when call channel is selected.
- ② Rotate **[DIAL]** to select the desired channel.



[M/CALL]

• Call channel indication



• Weather channel indication



- ① Push and hold **[MR/CALL]** for 1 sec. to select the call channels.
  - Weather channels cannot be selected by the HM-133.
- ② Push **[▲]** or **[▼]** to select the desired call channel.

◇ DR (D-STAR Repeater) mode

DR (D-STAR Repeater) mode is used for D-STAR repeater operation. In this mode, you can select the pre-programmed repeaters and UR call sign easily.

- ① Push **[DR]** to select the DR mode.
  - “**DR**” appears when the DR mode is selected.



[DR]

• DR mode indication

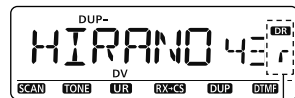

Appear

- ② Rotate **[DIAL]** to select the desired access repeater.
  - While rotating **[DIAL]**, S/Rf meter indicates group number.
  - Only programmed access repeaters in RPT-L menu can be selected. See p. 34 for RPT-L (repeater lists) programming details.

MENU ⇄ RPT-L ⇄ **ADD-L** (p. 34)

**NOTE:** If All reset is performed, “NO RPT” indication appears. In this case, you should program the repeater list before operating the DR mode.

## 2 BASIC OPERATION

### ■ Using the tuning dial

- ① Rotate **[DIAL]** to set the frequency.
  - If the VFO mode is not selected, push **[VFO/MHz]** to select the VFO mode.
  - The frequency changes in the selected tuning steps. (p. 15)
- ② To change the frequency in 10 MHz (or 1 MHz) steps, push **[VFO/MHz]** once or twice, then rotate **[DIAL]**. Push **[VFO/MHz]** again.
  - Pushing and holding **[VFO/MHz]** for 1 sec. starts scan function. If scan starts, push **[VFO/MHz]** again to cancel it.



[DIAL] [VFO/MHz]

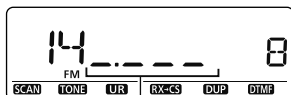

While 10 MHz tuning step is selected, the digits below 1 MHz disappear.

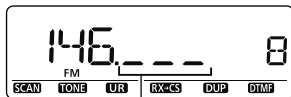

While 1 MHz tuning step is selected, the digits below 100kHz disappear.

### ■ Using the [▲]/[▼] keys



- ➔ Push **[▲]** or **[▼]** to select the desired frequency.
- Pushing and holding **[▲]/[▼]** for 1 sec. activates a scan. If scan starts, push **[▲]/[▼]** or **[CLR A(MW)]** to cancel it.



## ■ Using the keypad

The frequency can be set directly via numeral keys on the microphone.



- 1 Push [VFO/LOCK] to select the VFO mode, if necessary.
- 2 Push [ENT C(T-OFF)] to activate the keypad for digit input.
- 3 Push 6 keys to input a frequency.
  - When a digit is mistakenly input, push [ENT C(T-OFF)] to clear the input, then repeat input from the 1st digit.
  - Pushing [CLR A(MW)] clears input digits and retrieves the frequency.

**[EXAMPLE]:** Setting frequency to 145.3625 MHz.

Push		
Push		
Push		
Push		

## ■ Tuning step selection

Tuning steps are the minimum frequency change increments when you rotate [DIAL] or push [▲]/[▼] on the microphone. Independent tuning steps for each frequency band can be set for your convenience. The following tuning steps are available.

- 5 kHz\*    • 6.25 kHz\*    • 8.33 kHz†    • 10 kHz    • 12.5 kHz
- 15 kHz\*    • 20 kHz    • 25 kHz    • 30 kHz    • 50 kHz
- 100 kHz    • 125 kHz    • 200 kHz

\*Not selectable in 900 MHz band. †Appears for VHF air band only.

**NOTE:** For convenience, select a tuning step that matches the frequency intervals of repeaters in your area.

- 1 Enter "TS" in the MENU screen.

MENU ⇄ TS  
 (Push [MENU],) (Rotate [DIAL], then push [←](MONI).)

- Push [VFO/MHz] to select the VFO mode, if necessary.

- 2 Rotate [DIAL] to select the desired tuning step.
- 3 Push [MENU] to exit the set mode.

## 2 BASIC OPERATION

### ■ Lock functions

To prevent accidental frequency changes and unnecessary function access, use the lock function. The transceiver has 2 different lock functions.

#### ◇ Frequency lock

This function locks [DIAL] and keys electronically and can be used together with the microphone lock function.

[MENU 



Appears



➔ Push and hold [MENU 

- [PTT], [MONI] (monitor function only), [VOL] and [SQL] can be used while the channel lock function is in use. Also, TONE-1, TONE-2, DTMF tones or DTMF memory contents can be transmitted from the microphone.

VFO/LOCK 

➔ Push and hold [VFO/LOCK] for 1 sec. to turn the lock function ON or OFF.

#### ◇ Microphone keypad lock

This function locks the microphone keypad.



➔ Push [FUNC] then [SQL▼ D(16KEY-L)] to turn the microphone keypad lock function ON or OFF.

- [PTT], [VFO/LOCK], [MR/CALL], [BAND], [▲], [▼], [F-1], [F-2], [DTMF-S] and [FUNC] on the microphone can be used.
- All keys on the transceiver can be used.
- The keypad lock function is released when the power is turned OFF then ON again.

## ■ Receiving

- ① Set the audio level.
  - ➔ Push **[MONI]** to open the squelch.
  - ➔ Rotate **[VOL]** to adjust the audio level.
  - ➔ Push **[MONI]** to close the squelch.
- ② Set the squelch level.
  - ➔ Rotate **[SQL]** fully counterclockwise in advance, then rotate **[SQL]** clockwise until the noise just disappears.
    - When interference due to strong signals is received, rotate **[SQL]** clockwise past 13 o'clock for attenuator operation. (p. 19)
- ③ Set the operating frequency. (pgs. 14, 15)
- ④ When receiving a signal on the selected frequency, squelch opens and the transceiver emits audio.



Appears when receiving a signal.

• “BUSY” appears and the S/R/F indicator shows the relative signal strength for the received signal.

✓ **CONVENIENT!**

The audio and squelch level can also be adjusted with **[VOL▲ (TONE-1)]/[VOL▼ 0 (TONE-2)]** and **[SQL▲ D (MUTE)]/[SQL▼ # (16KEY-L)]**, respectively.

- “VOL” for audio or “SQL” for squelch appears during set.



Show set level

## ■ Transmitting

**CAUTION:** Transmitting without an antenna may damage the transceiver.

**NOTE:** To prevent interference, listen on the channel before transmitting by pushing **[MONI]**, or **[MONI 1 (BANK)]** on the microphone.

- ① Set the operating frequency. (pgs. 14, 15)
  - Select output power if desired. See the section at next page for details.
- ② Push and hold **[PTT]** to transmit.
  - “**T X**” appears.
  - The S/R/F indicator shows the output power selection.
  - A one-touch PTT function is available. See p. 21 for details.
- ③ Speak into the microphone using your normal voice level.
  - DO NOT hold the microphone too close to your mouth or speak too loudly. This may distort the signal.
- ④ Release **[PTT]** to return to receive.

**IMPORTANT! (for 50 W transmission):**  
 The ID-880H is equipped with protection circuits to protect the power amplifier circuit from high temperature. When the transceiver temperature becomes extremely high, the transceiver reduces transmit output power to 5 W (approx.) automatically.

## 2 BASIC OPERATION

### ■ Selecting output power

The transceiver has 3 output power levels to suit your operating requirements. Low output powers during short-distance communications may reduce the possibility of interference to other stations and will reduce current consumption.

- ➔ Push **[LOW]** several times to select the output power.
  - “LOW” appears when low output power; “MID” appears when middle output power; no indication appears when high output power is selected.
  - The output power can be changed while transmitting.

S/R/F INDICATOR	POWER OUTPUT	
	VHF/UHF	Taiwan
High: ██████████	50 W/50 W	25 W
Mid: ██████	15 W*/15 W*	15 W*
Low: ████	5 W*/5 W*	5 W*

\*approx.

The microphone can also be used to select output power.

- ➔ Push **[HIGH 4(DTCS)]** for high output power; **[MID 5(DTCS(··))]** for middle output power; and **[LOW 6(DTMF)]** for low output power.
  - The output power can be changed via the microphone during receive only.

### ■ Operating mode selection

Operating modes are determined by the modulation of the radio signals. The transceiver has total 5 operating modes (FM, FM-N, AM, AM-N and DV modes). The mode selection is stored independently for each band and memory channel.

Typically, AM mode is used for the air band (118–136.995 MHz), and only receive is available.

- ① Select the desired frequency band in the VFO mode, or the desired memory channel.
- ② Push and hold **[MODE](BAND)** for 1 sec., then rotate **[DIAL]** to select the desired operating mode between FM, FMN, AM, NAM and DV.
  - Push **[MODE](BAND)** again to return to the frequency indication.

[MODE]

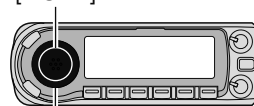

[DIAL]

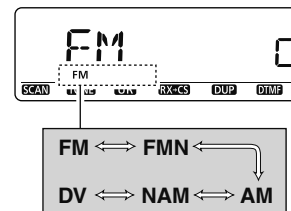

Selected operating mode is displayed.

## ■ Squelch attenuator

The transceiver has an RF attenuator related to the squelch level setting. Approx. 10 dB attenuation is obtained at maximum setting.

The squelch attenuator allows you to set the minimum signal level needed to open the squelch. The attenuator function can be deactivated in the FUNC set mode (SET).

- ➔ Rotate **[SQL]** clockwise past the 13 o'clock position to activate the squelch attenuator.
  - Attenuation level can be adjusted up to 10 dB (approx.) between 13 o'clock and fully clockwise position.

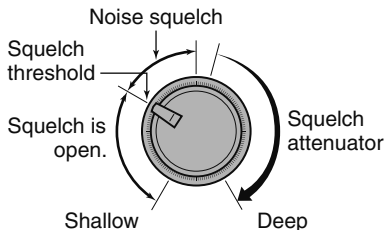

**NOTE:** The squelch attenuator functions even when the monitor function is in use. We recommend setting the **[SQL]** control between the 10 and 13 o'clock positions when using the monitor function.

### ◇ Squelch attenuator setting

- ① Enter "AT-ATT" in the FUNC set mode (SET).

MENU ⇄ SET ⇄ FUNC ⇄ **AT-ATT** (p. 127)  
 (Push **[MENU]**), (Rotate **[DIAL]**, then push **[←]**(MONI).)

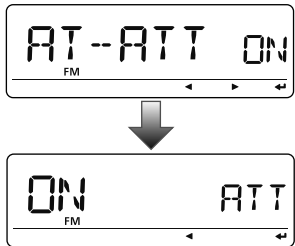
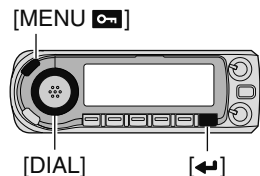

- ② Rotate **[DIAL]** to turn the squelch attenuator function ON or OFF.
  - Select "OFF" to deactivate the squelch attenuator function.
- ③ Push **[MENU]** to exit the set mode.

## 2 BASIC OPERATION

### ■ Monitor function

This function is used to listen to weak signals without disturbing the squelch setting.

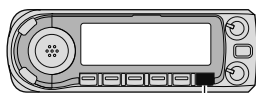

[MONI]

- ➔ Push **[MONI]** to open the squelch.
  - “BUSY” blinks.
  - Push **[MONI]** again to cancel the function.



- ➔ Push **[MONI 1(BANK)]** to open the squelch.
  - Push **[MONI 1(BANK)]** again to cancel the function.

**NOTE:** When the **[SQL]** adjustment is set too far clockwise, (13–17 o'clock position) the squelch attenuator is activated. To monitor weak signals on the operating frequency, deactivate the squelch attenuator function. See page 19 for details.

### ■ Audio mute function

This function temporarily mutes the audio without disturbing the volume setting. (microphone only)



- ➔ Push **[FUNC]** then **[SQL▲ D(MUTE)]** to mute audio signals.
  - Push **[CLR A(MW)]** (or any other key) to cancel the function.

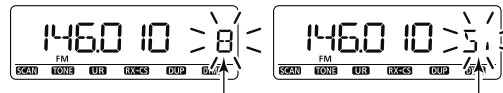

Shows above indications alternately

## ■ One-touch PTT function

The PTT switch can be operated as a one-touch PTT switch (each push toggles between transmit/receive). Using this function you can transmit without pushing and holding the PTT switch.

To prevent accidental, continuous transmissions with this function, the transceiver has a time-out timer. See p. 128 for details.



- ① Push [FUNC] then [PRIO 3(PTT-M)] to turn the one-touch PTT function ON.
  - The activity indicator lights green.
- ② Push [PTT] to transmit and push again to receive.
  - A beep sounds when transmission is started and a long beep sounds when returning to receive.
- ③ Push [FUNC] then [PRIO 3(PTT-M)] to turn the one-touch PTT function OFF.
  - The activity indicator goes out.

## ■ General

Repeaters allow you to extend the operational range of your radio because a repeater has much higher output power than the typical transceiver.

Usually, a repeater has independent frequencies for receive and transmit. The repeater may also require a subaudible tone for access.

Reference amateur radio handbooks and local ham magazines for details of local repeaters such as repeater input/output frequencies and locations.

### Repeater example;

Receives the 444.540 MHz signal and the detected audio signals are transmitted on 449.540 MHz simultaneously.

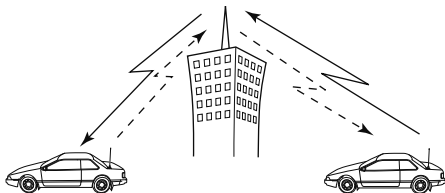

Station A:  
Tx: 444.540 MHz  
Rx: 449.540 MHz

Station B:  
Tx: 444.540 MHz  
Rx: 449.540 MHz

### • Repeater operation flow chart

#### Step 1:

Set the desired band to operate the repeater.

#### Step 2:

Set the desired receive frequency (repeater output frequency).

#### Step 3:

Set the duplex (shift) direction (- duplex or +duplex).

- Set the offset frequency (amount of shift), if required.

#### Step 4:

Set the subaudible tone (repeater tone) encoder function ON.

- Set the subaudible tone frequency, if required.

- Some versions (USA/CHN/EXP/KOR) of the ID-880H have the auto repeater function. Thus the steps 3 and 4 may not be necessary, depending on the setting.
- Repeater settings can be stored into a memory channel.



## ■ Accessing a repeater

- ① Set the receive frequency (repeater output frequency). (pgs. 14, 15)
- ② Push and hold **[DUP]**(LOW) for 1 sec. to enter the duplex setting condition.
- ③ Rotate **[DIAL]** to select minus duplex or plus duplex.
  - “DUP-” or “DUP” appears to indicate the transmit frequency for minus shift or plus shift, respectively.
  - When the auto repeater function is turned ON (available for the USA version only), steps ② to ⑤ are not necessary. (p. 28)
  - Push **[DUP]**(LOW) again to return to the frequency indication.

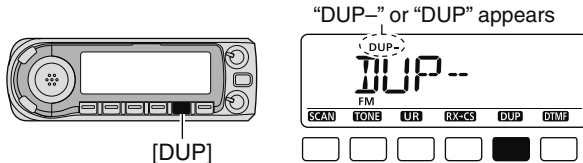

- ④ Push and hold **[TONE]**(M/CALL) for 1 sec. to enter the tone setting condition.
- ⑤ Rotate **[DIAL]** to turn ON the subaudible tone encoder, according to repeater requirements, then push **[TONE]**(M/CALL).
  - “T” appears
  - 88.5 Hz is set as the default; refer to p. 25 for tone frequency settings.
  - When the repeater requires a different tone system, see p. 26.

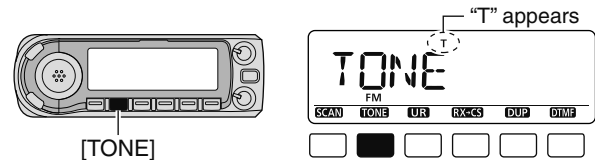

- ⑥ Push and hold **[PTT]** to transmit.
  - The displayed frequency automatically changes to the transmit frequency (repeater input frequency).
  - If “OFF” appears, confirm that the frequency offset (p. 27) is set correctly.
- ⑦ Release **[PTT]** to receive.



While receiving



While transmitting

- ⑧ Push **[MONI]** to check whether the other station's transmit signal can be received directly.
- ⑨ To return to simplex operation, push and hold **[DUP]**(LOW) then rotate **[DIAL]**, to clear the “DUP-” or “DUP” indicator.
  - Push **[DUP]**(LOW) again to return to frequency indication.
- ⑩ To turn OFF the subaudible tone encoder, push and hold **[TONE]**(M/CALL) then rotate **[DIAL]** until no tone indicator (OFF) appears.
  - Push **[TONE]**(M/CALL) again to return to the frequency indication.

### 3 REPEATER OPERATION

#### ■ Accessing repeater (continued)



1 Set the receive frequency (repeater output frequency). (pgs. 14, 15)



2 Push [DUP- 7(TONE)] to select minus duplex; push [DUP+ 8(TSQL ((·))) ] to select plus duplex.  
• “DUP-” or “DUP” appears.

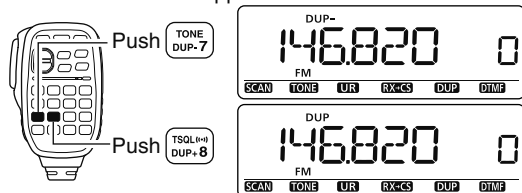

3 Push [FUNC] then [DUP- 7(TONE)] to turn ON the subaudible tone encoder according to repeater requirements.

- Refer to p. 25 for the tone frequency setting.
- When the repeater requires a different tone system, see p. 26.

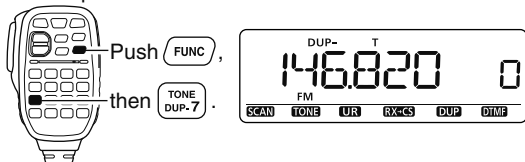

- 4 Push and hold [PTT] to transmit.
- 5 Release [PTT] to receive.
- 6 Push [MONI 1(BANK)] to check whether the other station's transmit signal can be received directly.



7 Push [SIMP 9(TSQL)] to return to simplex operation.  
• “DUP+” or “DUP-” indicator disappears.

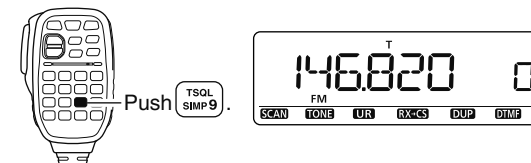

8 To turn OFF the subaudible tone encoder, push [FUNC] then [ENT C(T-OFF)].

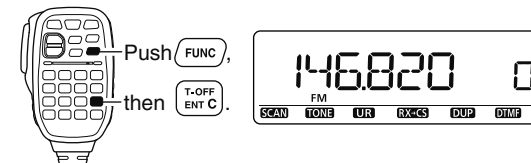

## ■ Subaudible tones (Encoder function)

### ◇ Subaudible tones

- ① Select mode/channel for which you wish to set the subaudible tones, such as the VFO mode or a memory/call channel. (Subaudible tone is available in FM/FM-N only.)
  - The subaudible tone frequency is independently programmed into each mode, band or channel.
- ② Enter "R TONE" in the DUP.T menu.

MENU ⇄ DUP.T ⇄ **R TONE** (p. 121)  
 (Push [MENU ]), (Rotate [DIAL], then push [←](MONI).)

[MENU 



[DIAL] [←]



- ③ Rotate [DIAL] to select and set the desired subaudible frequency, then push [←](MONI).
- ④ Push [MENU ] again to exit the DUP.T menu.

**NOTE:** The subaudible tone encoder frequency can be set in a memory/call channel temporarily. However, the set frequency is cleared once another memory channel or the VFO mode is selected. To store the tone frequency permanently, overwrite the channel information.



- ① Set mode/channel for which you wish to set the subaudible tones, such as the VFO mode or a memory/call channel. (Subaudible tone is available in FM/FM-N only.)
  - The subaudible tone frequency is independently programmed into each mode, band or channel.
- ② Enter "R TONE" in DUP.T menu.

MENU ⇄ DUP.T ⇄ **R TONE** (p. 121)  
 (Push [SET B(D-OFF)] to enter the MENU screen),  
 (Push [▲] or [▼], then push [SET B(D-OFF)].)

- ③ Push [▲] or [▼] to select the desired subaudible tone frequency then push [SET B(D-OFF)].

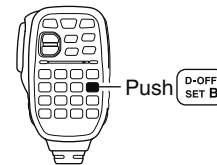

- ④ Push [CLR A(MW)] to return to the VFO mode.

### • Subaudible tone frequency list (unit: Hz)

67.0	79.7	94.8	110.9	131.8	156.7	171.3	186.2	203.5	229.1
69.3	82.5	97.4	114.8	136.5	159.8	173.8	189.9	206.5	233.6
71.9	85.4	100.0	118.8	141.3	162.2	177.3	192.8	210.7	241.8
74.4	88.5	103.5	123.0	146.2	165.5	179.9	196.6	218.1	250.3
77.0	91.5	107.2	127.3	151.4	167.9	183.5	199.5	225.7	254.1

### 3 REPEATER OPERATION

#### ◇ DTMF tones



➔ Push [DTMF-S], then push the keys of the desired DTMF digits.

- The function indicator lights green.
- 0-9, A-D, \*(E) and #(F) are available.
- When "□" is displayed in place of the 100 MHz digit, cancel the DTMF memory encoder in advance. (p. 143)
- Push [DTMF-S] again to return the keypad to normal function control.

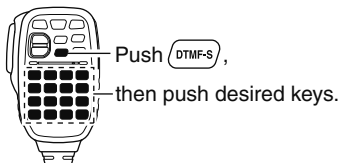

#### ✓ For your convenience!

The transceiver has 16 DTMF memory channels for auto-patch operation. See p. 142 for details.

#### ◇ 1750 Hz tone

The microphone has 1750 Hz tone capability, used for ring tone when calling, etc.



1 Push [FUNC].

- The function indicator lights orange.

2 Push [\*(TONE-1)] to transmit a 1750 Hz tone call signal for 0.5 sec.; push and hold [0(TONE-2)] to transmit a 1750 Hz tone call signal for an arbitrary period.

- The function indicator goes out automatically.

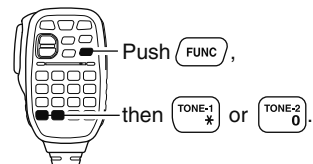

## Frequency offset

When communicating through a repeater, the transmit frequency is shifted from the receive frequency by an amount determined by the frequency offset. Independent offset frequencies can be set for each operating frequency band.

- 1 Select the desired mode/channel for which you wish to set the offset frequency, such as the VFO mode or a memory/call channel.
  - The frequency offset is independently programmed into each mode, band or channel.

- 2 Enter "OFFSET" in the DUP.T menu.

MENU ⇨ DUP.T ⇨ **OFFSET** (p. 121)  
 (Push [MENU ]), (Rotate [DIAL], then push [←](MONI).)

[MENU ]

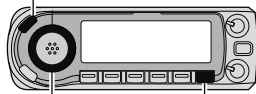

[DIAL]

[←]

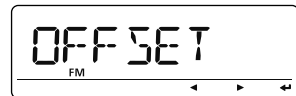

- 3 Rotate [DIAL] to set the desired frequency offset, then push [←](MONI).

- Push [VFO/MHz] to turn 10 MHz or 1 MHz tuning ON or OFF

- 4 Push [MENU ] again to exit the DUP.T menu.



- 1 Push [BAND] to select the desired band.
  - Enter the desired frequency via the keypad if necessary.
- 2 Select the desired mode/channel for which you wish to set the offset frequency, such as the VFO mode or a memory/call channel.
  - The frequency offset can be independently programmed into each mode, band or channel.
- 3 Enter "OFFSET" in the DUP.T menu.
 

MENU ⇨ DUP.T ⇨ **OFFSET** (p. 121)  
 (Push [SET B(D-OFF)] to enter the MENU screen),  
 (Push [▲] or [▼], then push [SET B(D-OFF)].)
- 4 Push [▲] or [▼] to set the desired offset.
  - Direct frequency entry from the keypad is not possible.
- 5 Push [CLR A(MW)] to exit the set mode.

**NOTE:** The frequency offset can be set in a memory/call channel temporarily. However, the set frequency is cleared once another memory channel or the VFO mode is selected. To store the frequency offset permanently, overwrite the channel information.

### 3 REPEATER OPERATION

#### ■ Auto repeater

The USA, China, Export and Korean versions automatically use standard repeater settings (duplex ON/OFF, duplex direction, tone encoder ON/OFF) when the operating frequency falls within or outside of the general repeater output frequency range. The offset and repeater tone frequencies are not changed by the auto repeater function. Reset these frequencies, if necessary.

#### ◇ Frequency range and offset direction

##### • USA/CHN/EXP versions

FREQUENCY RANGE	SHIFT DIRECTION
145.200–145.495 MHz 146.610–146.995 MHz	“DUP–” appears
147.000–147.395 MHz	“DUP+” appears
442.000–444.995 MHz	“DUP+” appears
447.000–449.995 MHz	“DUP–” appears

##### • KOR version

FREQUENCY RANGE	SHIFT DIRECTION
439.000–440.000 MHz	“DUP–” appears

#### USA/CHN/EXP/KOR versions only

- ① Enter “AUTORP” in the FUNC set mode (SET).

MENU ⇨ SET ⇨ FUNC ⇨ **AUTORP** (p. 128)  
(Push [MENU ]), (Rotate [DIAL]), then push [←] (MONI).)

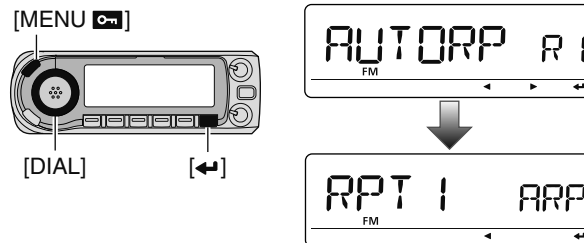

- ② Rotate [DIAL] to select the auto repeater setting.

##### [USA/CHN/EXP versions]:

- “RPT1” : Activates duplex only. (default)
- “RPT2” : Activates duplex and tone.
- “OFF” : Auto repeater function is turned OFF.

##### [KOR version]:

- “ON” : Activates duplex and tone. (default)
- “OFF” : Auto repeater function is turned OFF.

- ③ Push [MENU ] to exit the set mode.

## ■ About the D-STAR system

In the D-STAR (Digital Smart Technologies for Amateur Radio) system, repeater linking via a 10 GHz backbone and/or internet gateway provides you with much wider coverage range during digital voice mode operation.

### • D-STAR system outline

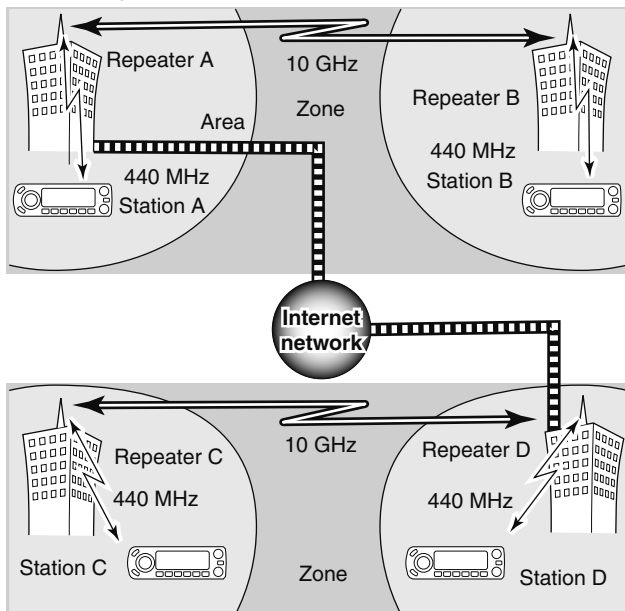

In traditional repeater operation, stations that are communicating must both be in the repeater's operating area. However, D-STAR repeaters can be linked via a 10 GHz backbone, as shown in the illustration at left. Using D-STAR, stations A and B can communicate even though they are in widely separated repeater operating areas.

Furthermore, D-STAR repeaters can be linked through an internet gateway, which can extend the communication range dramatically. For example, when station B uses the internet gateway connection, it can communicate with station C even though they are thousands of miles apart! By using the gateway connection, long distance communication is possible using 144 or 440 MHz digital voice!

In the D-STAR system, an independent repeater's operating area is called an Area and a group that of linked repeaters via a 10 GHz backbone is called a Zone.

#### **About time-out timer function**

The ID-880H has a time-out timer function for digital repeater operation. The timer limits a continuous transmission to approx. 10 min. Warning beeps will sound approx. 30 sec. before time-out and then again immediately before time-out.

## 4 DV MODE PROGRAMMING

### ◇ System description

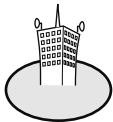
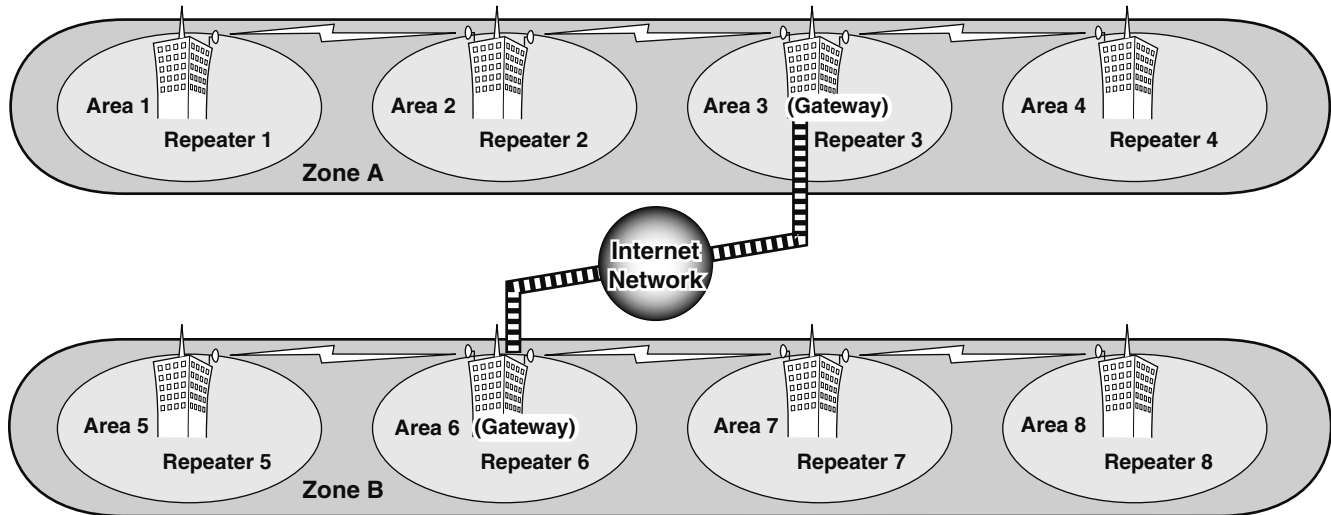

#### **Area:**

The Area is the communication range that is covered by a single repeater. The repeater is called an area repeater in the D-STAR system.



#### **Link repeater:**

The microwave (10 GHz) link repeater provides to linking with another repeater site (Area) for zone construction.



#### **Zone:**

The Zone is composed of several areas, that are linked by a 10 GHz microwave link. The areas 1 to 4 and 5 to 8 make up a zone at the example above.

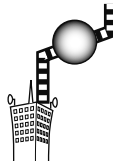

#### **Gateway repeater:**

Gateway repeaters provide communications between different zones via the internet. The repeater 3 and 6 are gateway repeaters at the example above.



## ■ Call sign programming

Four types of current call sign memory are available; "MY" (my call sign=your own call sign) "UR" (your call sign=other station call sign) "RPT1" (access repeater call sign) and "RPT2" (linked repeater call sign). Each call sign can be programmed with up to 8 characters.

In addition, "MY" can store up to 6 call signs, and "UR" can store up to 60 call signs in the call sign memory. Up to 300 repeater call signs can be stored in the repeater list.

### ◇ Your own call sign programming

Your own call sign must be programmed for both digital voice and low-speed data communications (including GPS transmission).

- 1 Enter "MY" in call sign screen.

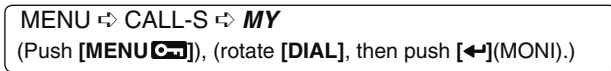

- MY call sign screen is displayed.

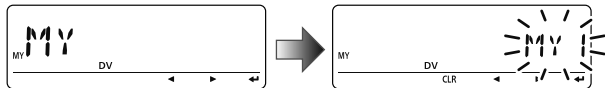

- 2 Rotate [DIAL] to select the desired call sign memory, "MY1" to "MY6."

- 3 Push [LOW] (LOW) to enter call sign programming mode.
  - The 1st digit blinks.

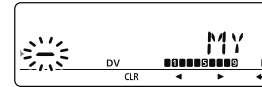

- 4 Rotate [DIAL] to select the desired character or code.
  - Push [LOW] (LOW) to move the cursor right; push [CS] (CS) to move the cursor left.

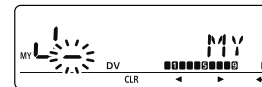

- 5 Repeat the step 4 to enter your own call sign.
  - Call sign can be up to 8 digits long.
  - If an unwanted character is entered, push [LOW] (LOW) or [CS] (CS) to select the character, then push [DR] (DR) to erase the selected character, or push and hold [DR] (DR) for 1 sec. to erase all characters following the cursor.
  - To program a note (up to 4 characters, for operating radio type, area, etc.), go to step 6, otherwise go to step 8.
- 6 Push [LOW] (LOW) several times to set the cursor beside "/" indication.

## 4 DV MODE PROGRAMMING

- ⑦ Repeat step ④ (at previous page) to program the desired 4 character note.



- ⑧ Push [←](MONI) to store the programmed call sign with note and return to call sign screen.

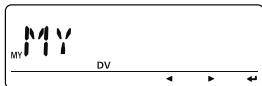

- ⑨ Push [MENU] to return to frequency indication.

### ◇ Station call sign programming

Station call sign must be programmed to call a specific station as well as for repeater operation in both digital voice and low-speed data communications.

- ① Enter "UR" in call sign screen.

MENU ⇨ CALL-S ⇨ **UR**  
(Push [MENU],) (rotate [DIAL], then push [←](MONI).)

- UR call sign screen is displayed.

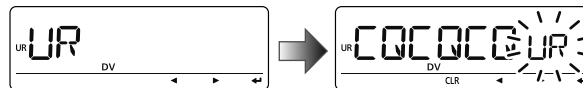

- ② Rotate [DIAL] to select the desired call sign memory, "U01" to "U60."

- ③ Push [▶](LOW) to enter call sign programming mode.
- The 1st digit blinks.

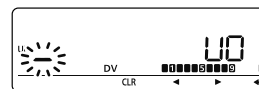

- ④ Rotate [DIAL] to select the desired character or code.

- Push [▶](LOW) or [←](CS) to move the cursor right or left, respectively.

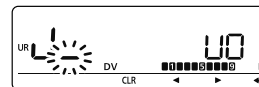

- ⑤ Repeat the step ④ to enter the desired station call sign.
  - Up to an 8 digit call sign can be set.
  - If an unwanted character is entered, push **[▶]**(LOW) or **[◀]**(CS) to select the character, then push **[CLR]**(DR) to erase the selected character, or push and hold **[CLR]**(DR) for 1 sec. to erase all characters following the cursor.
- ⑥ Push **[←]**(MONI) to store the programmed call sign and return to UR call sign screen.



- ⑦ Push **[MENU]** to return to frequency indication.

**✓ For your information**

The ID-880H has a call sign edit record function. When editing a call sign stored in a call sign memory (or regular memory/call channel), the default setting is to store the edited call sign into a blank channel automatically. (When all call sign memories are already programmed, the edited call sign will overwrite the selected channels call sign.) The programmed call sign can be over-written when the setting of "EDIT R" (Edit record) is set to OFF or SEL. (p. 135) However, you must manually over-write a reprogrammed call sign in regular memory/call channels (temporary operation without over-writing is possible).

**◇ Current repeater call sign programming**

"RPT1" or "RPT2" can store current call sign only, and repeater call signs must be stored in the repeater list (p. 34).

- ① Enter "RPT1" or "RPT2" in call sign screen.

MENU ⇨ CALL-S ⇨ **RPT1 or RPT2**  
 (Push **[MENU]**), (rotate **[DIAL]**), then push **[←]**(MONI).

- RPT1/RPT2 call sign screen is displayed.

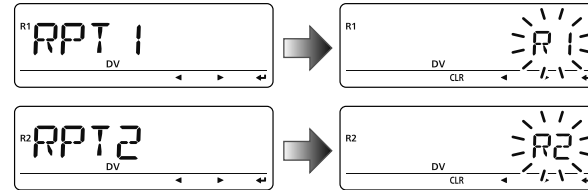

- ② Push **[▶]**(LOW) to enter call sign programming mode.
  - The 1st digit blinks.
- ③ Rotate **[DIAL]** to select the desired character or code.
  - Push **[▶]**(LOW) or **[◀]**(CS) to move the cursor right or left, respectively.
- ④ Repeat the step ③ to enter the desired repeater call sign.
  - Call sign can be up to 8 digits long.
  - If an unwanted character is entered, push **[▶]**(LOW) or **[◀]**(CS) to select the character, then push **[CLR]**(DR) to erase the selected character, or push and hold **[CLR]**(DR) for 1 sec. to erase all characters following the cursor.
- ⑤ Push **[←]**(MONI) to store the programmed call sign and returns to call sign screen.
- ⑥ Push **[MENU]** to return to frequency indication.

## 4 DV MODE PROGRAMMING

### ■ Repeater list

The ID-880H can store up to 300 repeater call signs. The repeater list also stores the repeater name and access repeater setting, etc.

The outline of repeater list is follows:

- ① Selection for new repeater program or changing a list
- ② Selection for a programmed repeater lists
- ③ Repeater programming (Repeater name, Call sign, Gateway repeater call sign, Repeater group, etc.)
- ④ Access repeater programming (Down link frequency, Duplex direction, Frequency offset)

#### ◇ Repeater list contents

The following information can be programmed into repeater lists:

- R-NAME (Repeater name) (pgs. 35, 39)
- CALL-S (Repeater call sign) (pgs. 35, 39)
- GW CAL (Gateway repeater's call sign) (pgs. 36, 40)
- GROUP (Repeater group) (p. 36)
- R1 USE (RPT1 use) (p. 37)

When R1 USE is selected YES, following contents appear.

- FREQ (Repeater output frequency) (p. 37)
- DUP (Duplex direction) (p. 38)
- OFF SET (Frequency offset) (p. 38)

**NOTE:** Repeater lists can be erased by static electricity, electric transients, etc. In addition, they can be erased by malfunction and during repairs. Therefore, we recommend that memory data be written down or be saved to a PC using the CS-80/880 CLONING SOFTWARE (free download).

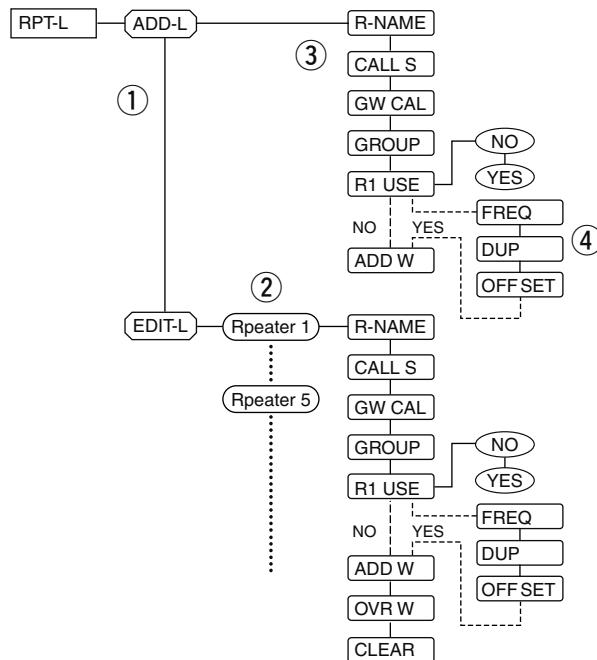

## ■ Repeater list programming

### ◇ New repeater list programming

- ① Enter “ADD-L” in RPT-L menu.

MENU ⇨ RPT-L ⇨ **ADD-L**  
 (Push [MENU], (rotate [DIAL], then push [←](MONI).)

- “R-NAME” appears.

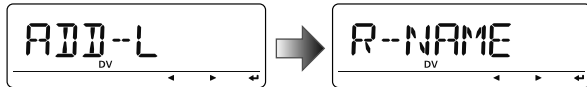

### Repeater name programming (R-NAME)

- ② Push [←](MONI) to enter the repeater name programming state. See p. 39 for repeater name programming details.
- Repeater name programming screen is displayed.

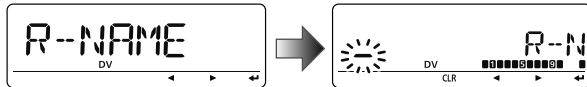

- ③ Program the repeater name, then push [←](MONI) to exit the state.
- Rotate [DIAL] to select the desired character, number, symbol or space.
  - Push [▶](LOW)/[◀](CS) to move the cursor right or left, respectively.
- ④ Rotate [DIAL] to select the next content (repeater call sign programming).

### Repeater call sign programming (CALL S)

- ⑤ Push [←](MONI) to enter the repeater call sign programming state. See p. 39 for repeater call sign programming details.
- Repeater call sign programming screen is displayed.

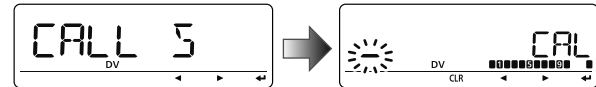

- ⑥ Program the repeater call sign, then push [←](MONI) to exit the state.
- Rotate [DIAL] to select the desired character, number, symbol (‘/’ only) or space.
  - Push [▶](LOW)/[◀](CS) to move the cursor right or left, respectively.
- ⑦ Rotate [DIAL] to select the next content (gateway repeater call sign programming).

### ✓ CONVENIENT!

After you program the repeater call sign, you can skip the other programming and store the list.

- ➔ Push [S.MW] to enter the memory write state, then push [←](MONI) to store the list.

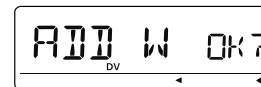

## 4 DV MODE PROGRAMMING

### Gateway repeater call sign programming (GW CAL)

⑧ Push [**←**](MONI) to enter the gateway repeater call sign programming state. See p. 40 for gateway repeater call sign programming details.

- Gateway repeater call sign programming screen is displayed.
- Programmed repeater call sign is displayed and the 8th digit is automatically added or replaced to “G.”

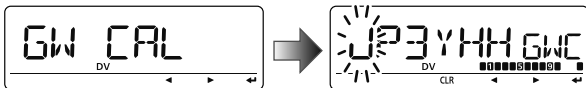

⑨ When the programmed repeater has gateway capability, push [**←**](MONI) to exit gateway repeater setting and skip to ⑫. Or when the programmed repeater has a different repeater for gateway communication, follow the next step ⑩.

- When the repeater does not have a gateway repeater, follow the next step ⑩, too.

⑩ Program the other gateway repeater call sign, then push [**←**](MONI) to exit the state.

- Rotate [**DIAL**] to select the desired character, number, symbol (/only) or space.
- Push [**▶**](LOW)/[**◀**](CS) to move the cursor right or left, respectively.
- Call sign can be up to 8 digits long, but 8th digit must be set to “G.”
- When the repeater does not have a gateway repeater, but has several linked repeaters, in the same zone, assign a common name to all repeaters. (up to 7 digits). In this case, you must set the 8th digit to “ ” (blank).

⑪ Rotate [**DIAL**] to select the next content (repeater group programming).

### Repeater group programming (GROUP)

The ID-880H has a total of 10 groups (0–9). You can assign and organize up to 300 repeater lists in the 10 groups. Group selection is helpful for quick recall of the desired repeater.

⑫ Push [**←**](MONI) to enter the repeater group programming state.

- Repeater group programming screen is displayed.
- Selected group number appears and group indicator blinks.

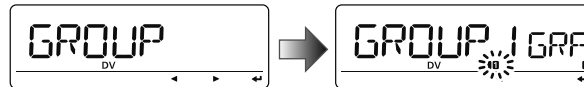

⑬ Rotate [**DIAL**] to select the desired repeater group.

- Selected group number appears and group indicator blinks.

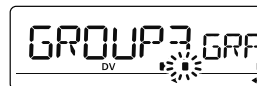

⑭ Push [**←**](MONI) to set the repeater group and exit the state.

⑮ Rotate [**DIAL**] to select the next content (access repeater setting).

**Access repeater setting (R1 USE)**

The programmed repeater lists are assigned to use or not to use the access repeater (RPT1) in the DR mode. To use for RPT1, repeater frequency, duplex direction and frequency offset must be programmed.

- ⑩ Push [←](MONI) to enter the access repeater programming state.

- Access repeater programming screen is displayed.

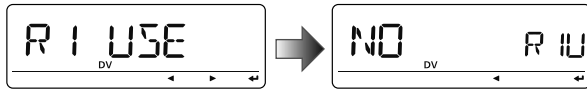

- ⑪ Rotate [DIAL] to select “YES” or “NO.”
  - When “NO” is selected, the repeater cannot be selected as the access repeater (RPT1) in the DR mode.
  - When “YES” is selected, the repeater can be selected as the access repeater (RPT1) in the DR mode.

- ⑫ Push [←](MONI) to exit the state.
- ➔ When “NO” is selected at step ⑪, skip to step ⑬.

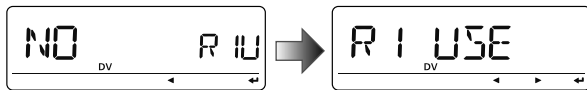

- ➔ When “YES” is selected at step ⑪, rotate [DIAL] to select the access repeater (RPT1) programming. Follow the next step ⑭ to program the repeater.

**Frequency programming (FREQ)**

This content appears when R1 USE is selected YES.

- ⑭ Push [←](MONI) to enter the frequency programming state.
  - Frequency programming screen is displayed.

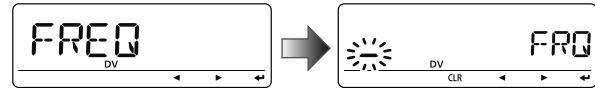

- ⑮ Rotate [DIAL] to select the frequency band.
  - The selected number blinks at 1st digit.
  - Push [▶](LOW) to move the cursor right; push [◀](CS) to move the cursor left.
  - Push and hold [CLR](DR) for 1 sec. to clear the displayed frequency.



- ⑯ Repeat step ⑮ until the repeater frequency is set.

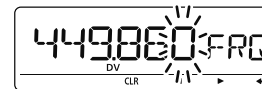

- ⑰ Push [←](MONI) to set the frequency and exit the state.
- ⑱ Rotate [DIAL] to select the next content (duplex direction programming).

## 4 DV MODE PROGRAMMING

### Duplex direction setting (DUP)

This content appears when R1 USE is selected YES.

- ②4 Push [←](MONI) to enter the duplex direction setting state.

- Duplex direction setting screen is displayed.

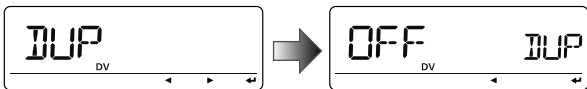

- ②5 Rotate [DIAL] to select the duplex direction.

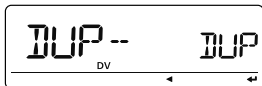

- ②6 Push [←](MONI) to set the duplex direction and exit the state.

- ②7 Rotate [DIAL] to select the next content (frequency offset programming).

### Frequency offset programming (OFF SET)

This content appears when R1 USE is selected YES.

- ②8 Push [←](MONI) to enter the offset frequency programming state.

- Frequency offset programming screen is displayed.

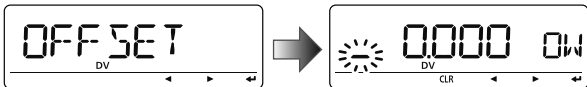

- ②9 Rotate [DIAL] to select the frequency offset.

- The selected number blinks.
- Push [▶](LOW) to move the cursor right; push [◀](CS) to move the cursor left.
- Push and hold [CLR](DR) for 1 sec. to clear the displayed frequency.



- ③0 Push [←](MONI) to set the frequency offset and exit the state.

### Storing the repeater list (ADD W)

- ③1 Rotate [DIAL] to select the store operation.

- ③2 Push [←](MONI) to enter storing state.

- "ADD W OK?" appears.

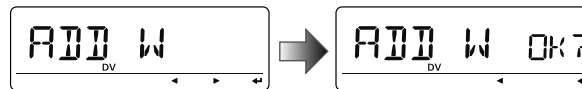

- ③3 Push [←](MONI) again to store the list.



◆ Repeater name programming (R-NAME)

① Push [←](MONI) to enter the repeater name programming state.

- Repeater name programming screen is displayed.
- The 1st digit blinks.

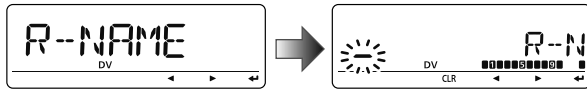

② Rotate [DIAL] to select the desired character, number, symbol or space.

- The selected character blinks.
- Push [▶](LOW) to move the cursor right; push [◀](CS) to move the cursor left.
- Push [CLR](DR) to erase the selected character, or push and hold [CLR](DR) for 1 sec. to erase all characters following the cursor.

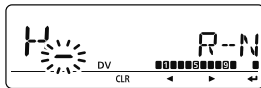

③ Repeat step ② until the desired repeater name is programmed.

- Up to an 8 digit name can be set.

④ Push [←](MONI) to program the repeater name and exit the state.

◆ Repeater call sign programming (CALL S)

① Push [←](MONI) to enter the repeater call sign programming state.

- Repeater call sign programming screen is displayed.
- The 1st digit blinks.

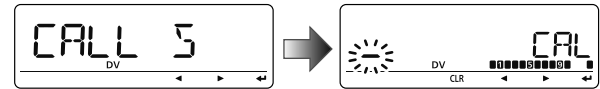

② Rotate [DIAL] to select the desired character, number or symbol ('/' only).

- The selected character blinks.
- Push [▶](LOW) to move the cursor right; push [◀](CS) to move the cursor left.
- Push [CLR](DR) to erase the selected character, or push and hold [CLR](DR) for 1 sec. to erase all characters following the cursor.



③ Repeat step ② until the desired repeater call sign is programmed.

- Call sign can be up to 8 digits long.

④ Push [←](MONI) to program the repeater call sign and exit the state.

## 4 DV MODE PROGRAMMING

### ◆ Gateway repeater call sign programming (GW CAL)

① Push [**←**](MONI) to enter the gateway repeater call sign programming.

- Gateway repeater call sign programming screen is displayed.
- Programmed repeater call sign is displayed, then the 1st character blinks.
- The 8th digit is automatically added or replaced to “G.”

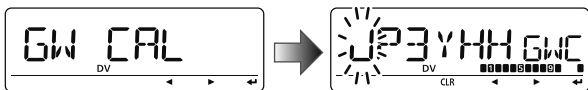

② Rotate [**DIAL**] to select the desired character, number, symbol (‘/’ only) or space.

- The selected character blinks.
- Push [**▶**](LOW) to move the cursor right; push [**◀**](CS) to move the cursor left.
- Push [**CLR**](DR) to erase the selected character, or push and hold [**CLR**](DR) for 1 sec. to erase all characters following the cursor.

③ Repeat step ② until the desired repeater call sign is programmed.

- Call sign can be up to 8 digits long, but 8th digit must be set to “G.”

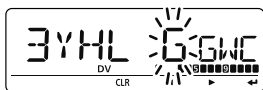

④ Push [**←**](MONI) to program the gateway repeater call sign and exit the state.

## ■ Changing a repeater list

This function re-programs a repeater list's contents. This is useful when already-programmed contents are mistaken or some contents are added to the list.

① Enter “EDIT-L” in RPT-L menu.

MENU ⇄ RPT-L ⇄ **EDIT-L**  
(Push [**MENU CLR**]), (rotate [**DIAL**]), then push [**←**](MONI).)

- Programmed repeater name appears.

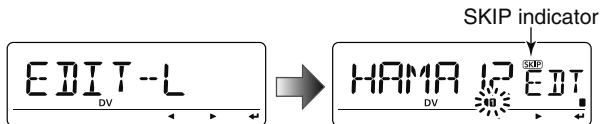

SKIP indicator shows the selected repeater can not be used for access repeater (RPT1) in DR mode as follow reasons.

- “R1 USE” is set to “NO.”
- Either “FREQ” (frequency) or “DUP” (duplex direction) has not been programmed.

② Push and hold [**BAND**] for 1 sec. to enter group selection, rotate [**DIAL**] to select the desired group (0–9), then push [**BAND**].

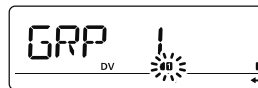

- ③ Rotate [DIAL] to select the desired repeater list to be changed.
- ④ Push [←](MONI) to enter the list.

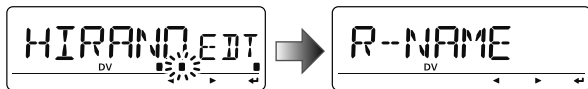

- ⑤ Rotate [DIAL] to select the content to be changed, then push [←](MONI) to enter the content and reprogram the content (see pages 35–38 for new repeater list programming details).
- ⑥ After programming is finished, rotate [DIAL] to select “ADD W” or “OVR W,” then push [←](MONI) to store to a new list or overwrite the selected list, respectively.

**When “ADD W” is selected;**

- “ADD W OK?” appears.

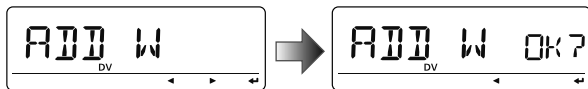

**When “OVR W” is selected;**

- “OVR W OK?” appears.

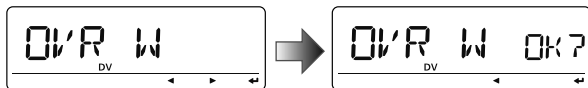

- ⑦ Push [←](MONI) again to store the list.

## ■ Clearing a repeater list

Contents of programmed list can be cleared (erased).

- ① Enter “EDIT-L” in RPT-L menu.

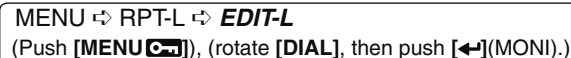

- Programmed repeater name appears.
- ② Rotate [DIAL] to select the desired repeater list to be erased.
  - Push and hold [BAND] for 1 sec. to enter group selection, rotate [DIAL] to select the desired group (0–9) then push [BAND].
- ③ Push [←](MONI) to enter the list.

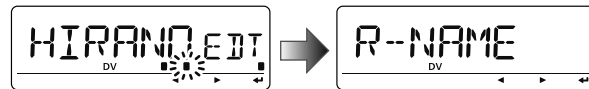

- ④ Rotate [DIAL] to select “CLEAR,” then push [←](MONI).
  - “CLEAR OK?” appears.

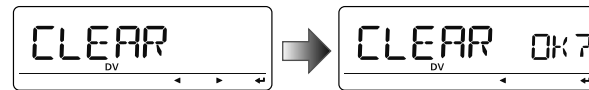

- ⑤ Push [←](MONI) again to clear the list.

## ■ Digital mode operation

The ID-880H can be operated in digital voice mode and low-speed data operation for both transmit and receive. It can also be connected to a GPS receiver (compatible with an RS-232 output/NMEA format/4800 bps/9600 bps) to transmit/receive position data.

## ■ Current call sign setting

Set the current call sign for DV operation as follows.

- ① Enter "CALL-S" in the MENU screen.

MENU ⇨ **CALL-S**

(Push [MENU 

- Call sign screen is displayed.

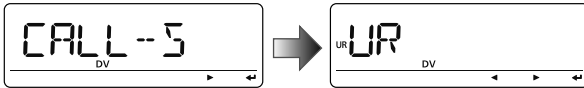

- ② Rotate [DIAL] to select the desired call sign group, "UR," RPT1," "RPT2" or "MY," then push [←](MONI).

- Current call sign is displayed.



### Quick entry

Push [CS] to enter the current call sign mode. See next page for details.

### • Call sign group

**UR** : Station call signs (U01–U60), "CQCQCQ" (U--) or repeater CQ\* (R-L) can be selected.

\* '/' plus repeater call sign (R-L), '/' stands for "CQCQCQ"

**RPT1** : "NOTUSE"\* (R--) or repeater call signs (R-L) can be selected.

\* Direct communication (NOT USE repeater)

**RPT2** : "NOTUSE"\* (R--) or repeater call signs (R-L) can be selected.

\* Direct communication or using area repeater only (NOT USE linked repeater)

**MY** : My call signs (MY1–MY6) can be selected.

- ③ Rotate [DIAL] to select the desired call sign.

Or push [▶](LOW) to enter the current call sign programming state (pgs. 31–33).

- When "UR," "RPT1" or "RPT2" is selected at step ②, push [BAND] several times to select the repeater call sign groups.
- When repeater call sign is selected at step ②, push [M/CALL] to toggle the call sign and repeater name indications.

- ④ Push [←](MONI) to set the selected call sign to the current call sign and exit the state.

- ⑤ Repeat steps ② to ④ to set the other current call sign.

- ⑥ Push [MENU 42

### ◇ Confirming current call sign

- 1 Push **[CS]** to enter the current call sign mode.
  - Current UR call sign is displayed.



Appears momentarily

- 2 Rotate **[DIAL]** to select and confirm the other current call sign.
  - (“UR”, “R1,” “R2” and “MY” appears in sequence.
  - When repeater call sign is selected, push **[M/CALL]** to toggle the call sign and repeater name indications.

#### When changing the call sign

- 1 Push **[←](MONI)** to enter the call sign selection mode.



- 2 Rotate **[DIAL]** to select the desired call sign, then push **[←](MONI)**.
  - When “UR,” “R1” or “R2” is selected, push **[BAND]** several times to select the repeater call sign groups.

- 3 Push **[CS]** again to return to frequency indication.

## ■ Receiving a D-STAR repeater

When the ID-880H receives a signal from a D-STAR repeater, it receives four call signs: caller’s call sign, called call sign, repeater call sign 1 (the repeater that caller accessed), and repeater call sign 2 (the linked repeater). You can copy the received call signs to current call signs, and you can also reply to a call.

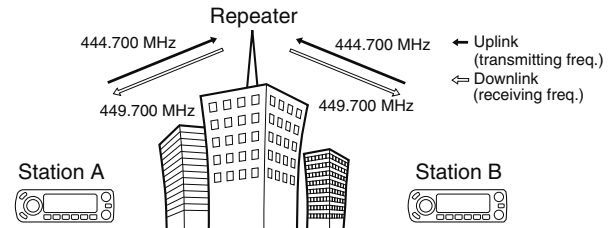

#### • Presetting

- 1 Set the desired repeater frequency. (pgs. 14, 15)
  - Select output power, if desired. (p. 18)
- 2 Set the shift direction of the transmit frequency. (DUP– or DUP; see p. 23 for details.)
  - When the auto repeater function is in use (U.S.A. and Korean versions only), this selection is not necessary. (p. 28)
- 3 Select the DV mode. (p. 18)
- 4 When signal is received, display indicates received call sign.

See next page for information about received call signs.

## 5 DV MODE OPERATION

### ■ Received call sign

When a call is received in the DV mode, the calling station and the repeater call signs being used can be stored into the received call record. The stored call signs are viewable in the following manner. Up to 20 calls can be recorded.

#### ◇ Desired call record indication

- ① Enter RX call sign set mode.

MENU → **RX CAL**

(Push [MENU] ), (rotate [DIAL], then push [←] (MONI).)

• RX call sign screen is displayed.

- ② Rotate [DIAL] to select the desired record channel.
- ③ To confirm the received call, push [←] (MONI) several times to select the desired call sign from CALLER, / (CALLER's note), CALLED, RXRPT1 and RXRPT2.

**CALLER** : The station call sign that made the call.

/ : 4 character note with call sign that made the call.

**CALLED** : The station call sign called by the caller.

**RXRPT1** : The repeater call sign used by the caller station in the same zone, or gateway repeater call sign of the down link repeater when the caller station is in a different zone.

**RXRPT2** : The repeater call sign for down link repeater.

- ④ Push [MENU] to return to frequency indication.

#### ✓ For your information

When receiving a call, the received station call sign is automatically displayed and scrolled in sequence on the frequency display. This can be turned OFF in the DV SET mode. (p.136)

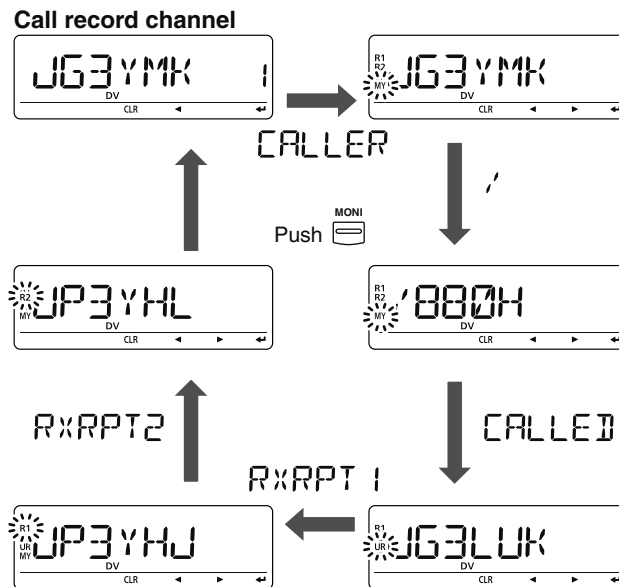

### ◇ One-touch reply using the call record

The stored call signs in the call record can be used to call the other station.

- ① After receiving a call, push and hold **[RX→CS]**(CS) for 1 sec.

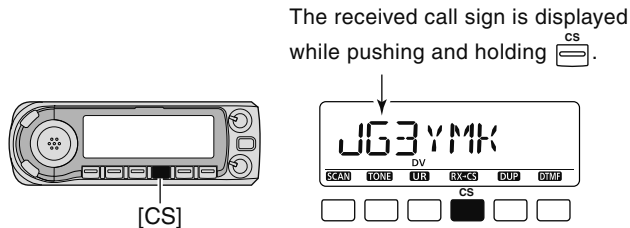

- Set your own call sign (MY) in advance. (pgs. 31, 42, 43)
  - The call sign in “CALLER” is stored as “UR,” “RXRPT1” is stored as “R2” and “RXRPT2” is stored as “R1.”
  - Error beeps sound when a call sign is received incorrectly, and no call sign is set in this case.
- ② Push **[PTT]** to transmit; release to receive.

### • Selecting a call record via RX CAL screen

- ① Select the desired record channel in steps ① and ② on the previous page.
- ② Push and hold **[MW]**(S.MW) for 1 sec. to copy the record channel to current call sign.
- ③ Push **[PTT]** to transmit; release to receive.

#### **Important!**

Setting call signs with the “One-touch reply using the call record” operation as at left are for temporary operation only. Therefore, the set call signs will be over-written when another call record is used to set call signs.

- Never saved into a call sign memory.

If you want to save the set call signs, see “Copying the call record contents into call sign memory” (p. 47) for details.

#### ✓ For your information

When a call specifying your call sign is received, the call signs of the calling station and the repeater it is using can be automatically used for operation.

- When “CALL W (RX call sign auto write)” (p. 135) is set to “AUTO,” the station call sign in “CALLER” is set to “UR” automatically.
- When “RPT W (Repeater call sign auto write)” (p. 135) is set to “AUTO,” the repeater call sign in “RXRPT1” is stored as “R2” and “RXRPT2” is stored as “R1” automatically.

**NOTE:** The One-touch reply function can be used on the same network system, but it cannot be used over different network systems.

## ■ Copying the call sign

### ◇ Copying the call sign memory contents

This function is convenient when modifying a part of the current call sign.

- Enter the call sign menu.

MENU ⇨ **CALL-S**  
 (Push [MENU] (M)), (rotate [DIAL], then push [←] (MONI).)

- Rotate [DIAL] to select “UR,” then push [←] (MONI).
- Rotate [DIAL] to select the desired call sign channel to be copied.
  - U01–U60 are available.

#### • When “AUTO” is set to “EDIT R” item

- Push [▶] (LOW) to select the call sign programming mode.
  - The 1st digit of the selected call sign blinks.

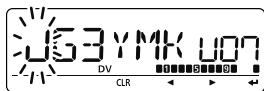

Blank channel is selected automatically.

- Modify the selected call sign as described in “Station call sign programming” (p. 32).
- Push [←] (MONI) to store the modified call sign into the selected blank channel.

#### NOTE:

Make sure that the “EDIT R (EDIT RECORD)” item in the DV SET mode is set to “AUTO” or “SEL” in advance. (p. 135)

NOTE: If no blank channel is available in the station call sign memory, select the desired call sign channel number as described in step ⑦ of “• When “SEL” is set to “EDIT R” item” below.

#### • When “SEL” is set to “EDIT R” item

- Push [▶] (LOW) to select the call sign programming mode.
  - The 1st digit of the selected call sign blinks.
- Modify the selected call sign as described in “Station call sign programming” (p. 32).
- Push [←] (MONI).
  - Call sign channel number blinks.



Call sign channel number blinks.

- Rotate [DIAL] to select the desired call sign channel to store.
- Push [←] (MONI) to store the modified call sign into the selected channel.



## ◇ Copying the call record contents into call sign memory

This is a way to copy the call record contents (“CALLER,” “RXRPT1” and “RXRPT2”) into call sign memory “UR” and repeater list “R-L” at the same time or individually.

- ① Enter RX CAL (RX call sign) mode.

MENU ⇄ **RX CAL**  
(Push [MENU] ( ), (rotate [DIAL]), then push [←] (MONI).)

• RX call sign screen is displayed.

- ② Rotate [DIAL] to select the desired record channel.  
③ Push [←] (MONI) several times to select the desired call sign from CALLER, / (CALLER’s note), CALLED, RXRPT1 and RXRPT2.

**CALLER** : The station call sign that made the call.

/ : 4 character note with call sign that made the call.

**CALLED** : The station call sign called by the caller.

**RXRPT1** : The repeater call sign used by the caller station in the same zone, or gateway repeater call sign of the down link repeater when the caller station is in a different zone.

**RXRPT2** : The repeater call sign for down link repeater.

- ④ Push [▶] (LOW) to enter copy select mode.

• Copy select screen is displayed.



- ⑤ Rotate [DIAL] to select the desired call sign to be copied from “C ALL,” “C UR01”–“C UR60,” “C R-L” and “CLEAR.”  
• “C ALL” selection won’t appear when either station call sign memory or repeater list has no blank channel.  
⑥ Push [←] (MONI) to copy the selected record’s contents into the appropriate call sign memory or repeater lists.

**C ALL** : Copy the caller call sign in “CALLER” to “UR” (station call sign memory) and the repeater call sign in “RXRPT1” / “RXRPT2” to the repeater lists. This selection won’t appear when either station call sign memory or repeater list has no blank channel.

**C UR01–** :

**C UR60** : Copy the caller call sign in “CALLER” to “UR” (station call sign memory). This selection appears when entering the copy select mode (step ④) from “CALLER” only.

**C R-L** : Copy the repeater call sign in “RXRPT1” / “RXRPT2” to the repeater lists. This selection appears when entering the copy select mode (step ④) from “RXRPT1” or “RXRPT2” only.

**CLEAR** : Clear (erase) the selected call record contents.

- ⑦ Push [MENU] ( ) to return to frequency indication.

## ■ DR (D-STAR Repeater) mode operation

DR (D-STAR Repeater) mode is used for D-STAR repeater operation. In this mode, you can select the pre-programmed repeaters and UR call sign by using [DIAL].

### • DR mode operation flow chart

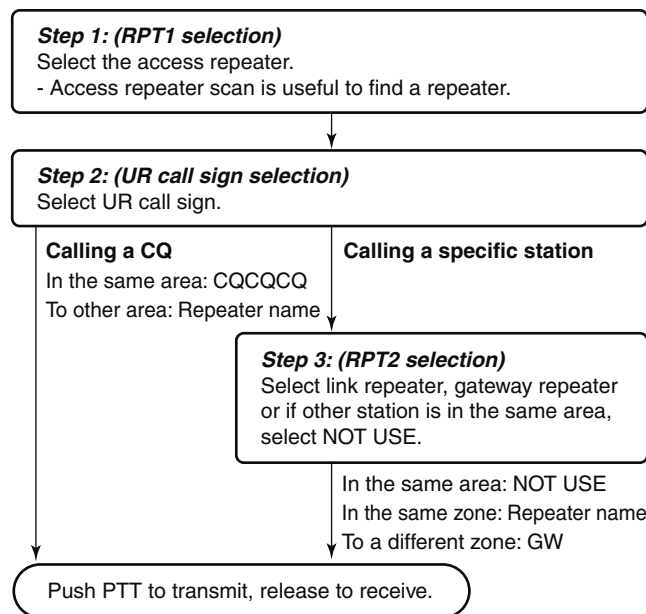

• Repeater settings can be stored into a memory channel.

### ◇ Access repeater scan

- ① Push [DR] to select the DR mode.
  - The DV mode is selected automatically.
- ② Push and hold [SCAN](VFO/MHz) for 1 sec. to start the scan.
  - Scan pauses when a signal is received.
  - Rotate [DIAL] to change the scanning direction, or resumes manually.
  - Push [SCAN](VFO/MHz) to stop the scan.

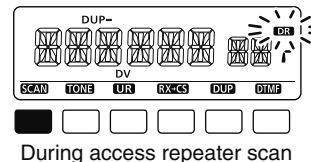
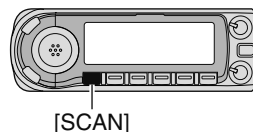

### • Skip setting

Unwanted access repeater can be skipped for rapid selection or scan.

- ① Enter “EDIT-L” in RPT-L menu.

MENU ⇄ RPT-L ⇄ **EDIT-L**  
(Push [MENU], (rotate [DIAL], then push [←](MONI).)

- Programmed repeater name appears.
- ② Rotate [DIAL] to select the desired access repeater to be skipped.
- Push and hold [BAND] for 1 sec. to enter group selection, rotate [DIAL] to select the desired group (0–9) then push [BAND].
- ③ Push [DR] to toggle the skip setting ON or OFF.
- “SKIP” appears when the channel is set as skip channel.

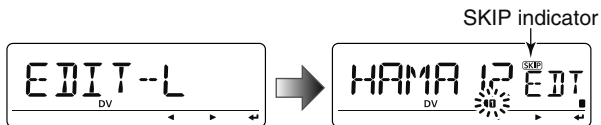

SKIP indicator shows the selected repeater can not be used for access repeater (RPT1) in DR mode as follow reasons.

- “R1 USE” is set to “NO.”
- Either “FREQ” (frequency) or “DUP” (duplex direction) has not been programmed.

## 5 DV MODE OPERATION

### ■ Calling CQ

#### STEP 1 (RPT1 selection)

① Push [DR] to enter the DR mode.

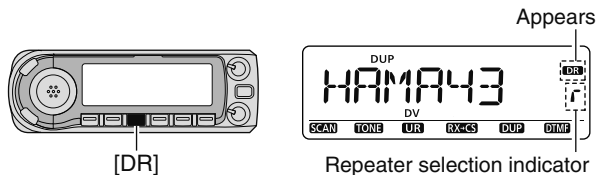

② Select the repeater group.

#### Selecting the repeater group

① Push and hold [BAND] for 1 sec., then rotate [DIAL] to select the desired repeater group.

- Only assigned groups from GRP 1–GRP 9 and GRP 0 are selectable.

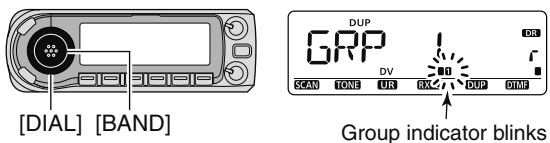

② Push [BAND] again to release the group selection.

③ Rotate [DIAL] to select the access repeater.

- Only repeaters that have access repeater settings programmed are selectable.
- Group indicator appears momentarily when rotating [DIAL].
- Access repeater scan can be used for the selection. (p. 48)

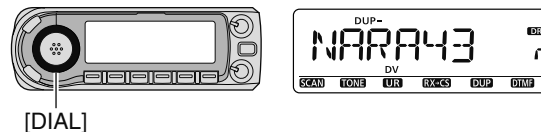

#### STEP 2 (UR call sign selection)

④ Push and hold [UR](DR) for 1 sec. to enter the your call sign selection.

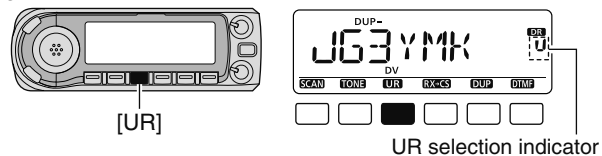

⑤ Select the group as step ②.

- Only assigned GRP 1–GRP 9, GRP 0, GRP UR and GRP CQ are selectable.
- UR call signs are selectable in GRP UR.
- “CQCQCQ” is selectable in GRP CQ.
- Push [BAND] several times to select “GRP UR,” “GRP CQ” and “GRP RP.”

◇ Calling CQ in the same area (Area CQ)

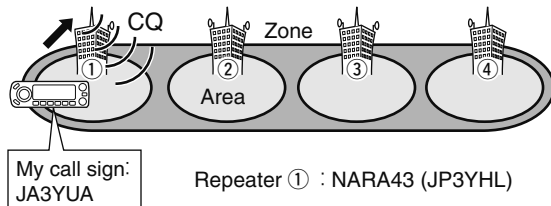

Continued instructions from step ⑤ on page 50.

- ⑥ Push **[BAND]** several times to select “GRP CQ,” then “CQCQCQ” is selected as UR call sign automatically.
  - The linked repeater (RPT2) setting is set to “NOT USE” automatically.
- ⑦ Push **[PTT]** to transmit; release to receive.

◇ Calling CQ in another area (Zone CQ/Different zone CQ)

• Calling CQ in the same zone (Zone CQ)

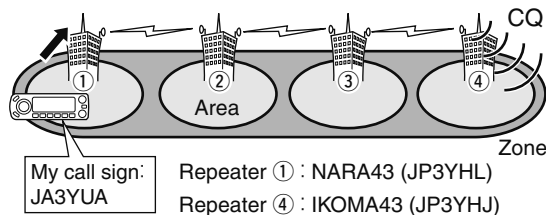

• Calling CQ in another zone (Different zone CQ)

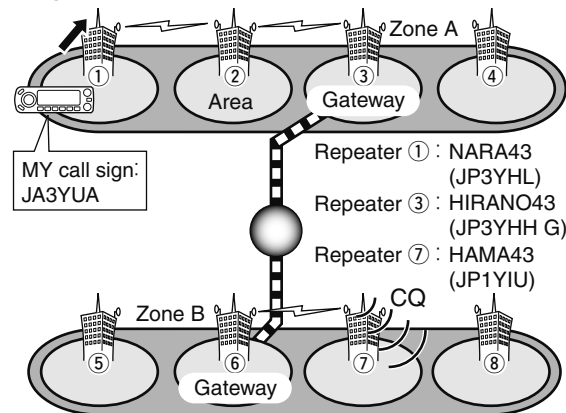

Continued instructions from step ⑤ on page 50.

- ⑥ Rotate **[DIAL]** to select a desired repeater name.
  - Push **[BAND]** several times to select “GRP RP” in advance.

**Calling CQ in the same zone (Zone CQ)**  
The linked repeater (RPT2) is set to the selected repeater automatically.

**Calling CQ in another zone (Different zone CQ)**  
The linked repeater (RPT2) is set to the preset gateway repeater automatically.

- ⑦ Push **[PTT]** to transmit; release to receive.

## ■ Calling a specific station

### STEP 1 (RPT1 selection)

① Push [DR] to enter DR mode.

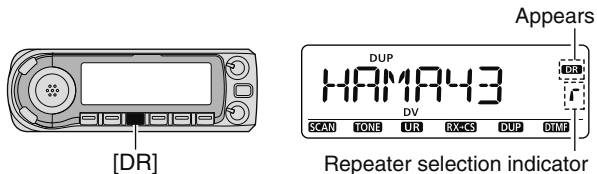

② Select the repeater group.

#### Selecting the repeater group

① Push and hold [BAND] for 1 sec., then rotate [DIAL] to select the desired repeater group.

- Only assigned groups from GRP 1–GRP 9 and GRP 0 are selectable.

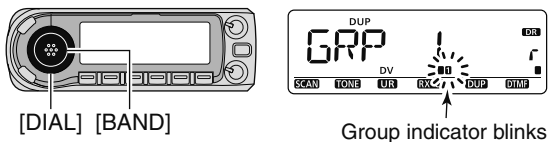

② Push [BAND] again to release the group selection.

③ Rotate [DIAL] to select the access repeater.

- Only repeaters that have access repeater settings programmed are selectable.
- Group indicator appears momentarily when rotating [DIAL].
- Access repeater scan can be used for the selection. (p. 48)

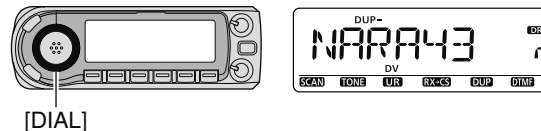

### STEP 2 (UR call sign selection)

④ Push and hold [UR](DR) for 1 sec. to enter UR call sign selection.

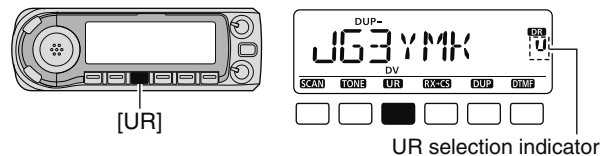

⑤ Rotate [DIAL] to select a specific station call sign.

- Push [BAND] several times to select "GRP UR" in advance.

◇ Calling a specific station in the same area (Area call)

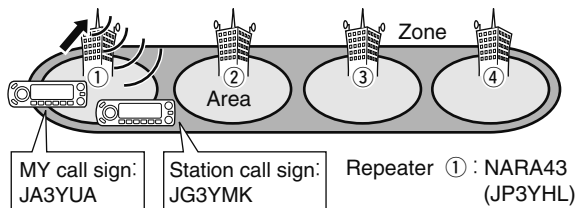

Continued instructions from step ⑤ on page 52.

**STEP 3 (RPT2 selection)**

- ⑥ Push and hold [UR](DR) for 1 sec. to enter the linked repeater (RPT2) selection.

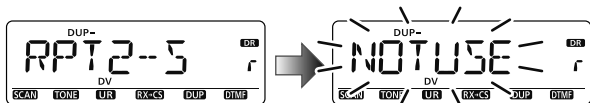

- ⑦ Rotate [DIAL] to select "NOT USE."



- ⑧ Push [UR](DR) to exit the linked repeater selection.  
 ⑨ Push [PTT] to transmit; release to receive.

◇ Calling a specific station in the same zone (Zone call)

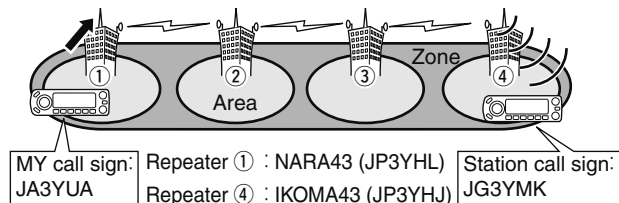

Continued instructions from step ⑤ on page 52.

**STEP 3 (RPT2 selection)**

- ⑥ Push and hold [UR](DR) for 1 sec. to enter the linked repeater (RPT2) selection.

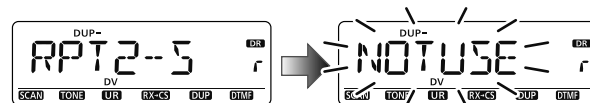

- ⑦ Rotate [DIAL] to select the linked repeater in the same zone.

- Only repeaters that have programmed same gateway repeater appear.

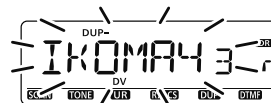

- ⑧ Push [UR](DR) to exit the linked repeater selection.  
 ⑨ Push [PTT] to transmit; release to receive.

## 5 DV MODE OPERATION

### ◇ Calling a specific station in another zone (Different zone call)

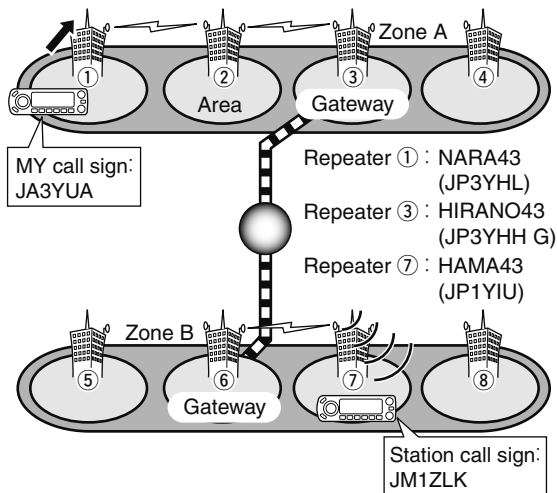

**NOTE:** If the other station has accessed the repeater at least once, the D-STAR system will connect to the repeater automatically even you don't know where the station is (possible in the same area as you, or in the same zone or a different zone). In this case, you select "GW" as the RPT2 selection. The Auto gateway setting "GW SET" is helpful (p. 136).

Continued instructions from step ⑤ on page 52.

#### STEP 3 (RPT2 selection)

⑥ Push and hold [UR](DR) for 1 sec. to enter the linked repeater (RPT2) selection.

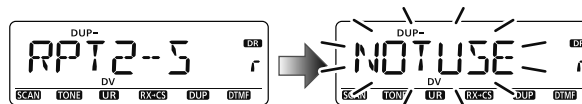

⑦ Rotate [DIAL] to select the preset gateway repeater "GW."  
• Only repeaters that have programmed same gateway repeater appear.

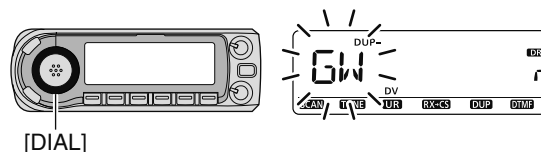

⑧ Push [UR](DR) to exit the linked repeater selection.

⑨ Push [PTT] to transmit; release to receive.



### ◇ Confirming the setting

- ① Push **[CS]** to enter the setting confirmation screen.
  - Either “UR,” “R1” or “R2” call sign is displayed.

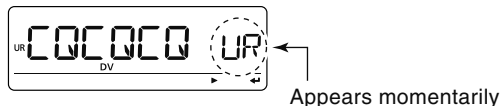

- ② Rotate **[DIAL]** to select and confirm the other current call sign.
  - “UR,” “R1,” “R2,” “MY” and “FRQ” appears in sequence.
- ③ Push **[M/CALL]** to toggle the name indication and call sign indication.
  - Name indication is available only for repeater call signs that have programmed repeater names.

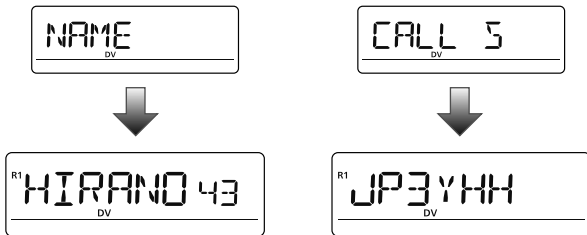

- ④ Push **[CS]** again to exit the setting confirmation screen.

### ◇ One-touch reply using the call record in the DR mode

The stored call signs in the call record can be used to the call. See p. 45 for “One-touch reply using the call record” (except the DR mode) for reference.

- ① After receiving a call, push and hold **[RX→CS](CS)** for 1 sec. to select the desired call record.

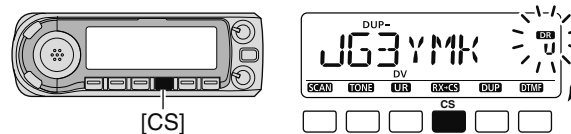

- The call sign in “CALLER” is stored as “UR.”
  - Error beeps sound when a call sign is received incorrectly, and no call sign is set in this case.
- ② Push **[PTT]** to transmit; release to receive.
  - ③ Push **[DR]** to return to the previous setting.
    - Push and hold **[RX→CS](CS)** also returns to the previous setting.

**NOTE:** If you want to save this temporary setting, push and hold **[MW](S.MW)** for 1 sec., then rotate **[DIAL]** to select the desired memory channel, call channel or VFO. Then push and hold **[MW](S.MW)** again to store the setting. (If you push and hold **[MW](S.MW)** for 2 sec. at first pushing, the setting is stored to the VFO automatically.)

## ■ Simplex operation in the VFO

### ◇ Sending CQ

- ① Set the desired frequency. (pgs. 14, 15)
  - Select output power, if desired. (p. 18)
- ② Set the current MY call sign to your own call sign. (p. 42)
- ③ Set the current UR call sign. (p. 42)

#### UR call sign selection

- ① Push and hold **[UR]**(DR) for 1 sec. to enter UR call sign selection mode.
  - Push **[BAND]** several times to select “GRP CQ” (CQCQCQ) “GRP UR” (UR call sign memories) and “CS” (current call sign).
  - The DV mode is automatically selected.

- ② Rotate **[DIAL]** to select “CQCQCQ.”

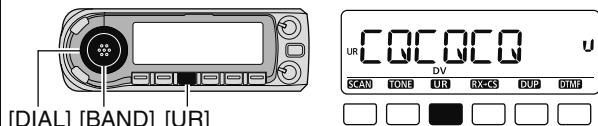

- ③ Push **[UR]**(DR) to return to frequency indication mode.

- ④ Push and hold **[PTT]** to transmit and speak into the microphone at normal voice level.
  - “**T X**” appears and the RF meter shows the output power.
  - “CQCQCQ” is displayed and scrolled in sequence on the frequency display depending on “TX CS” setting (p. 136).

- ⑤ Release **[PTT]** to return to receive.
  - The other station’s call sign will be received.
  - Received call signs can be stored into the received call record automatically. See page 44 for details.

#### • Current call sign setting example (Simplex CQ)

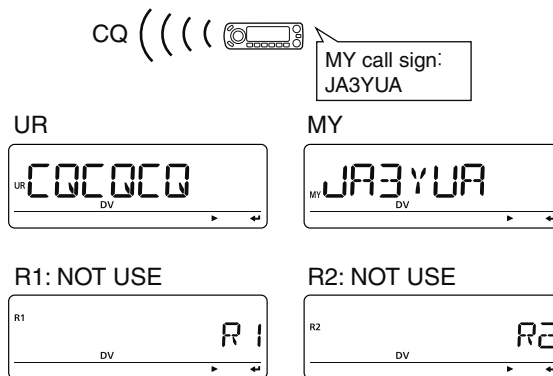

#### Confirmation

- ① Push **[CS]** to enter the current call sign mode.
  - Current UR call sign is displayed.
- ② Rotate **[DIAL]** to select and confirm the other current call sign.
  - (“UR”, “R1”, “R2” and “MY” appears in sequence.

◇ **Calling a specific station**

- ① Set the desired frequency. (pgs. 14, 15)
  - Select output power, if desired. (p. 18)
- ② Set the current MY call sign to your own call sign. (p. 42)
- ③ Set the current UR call sign. (p. 42)

**UR call sign selection**

- ① Push and hold **[UR](DR)** for 1 sec. to enter UR call sign selection mode.
  - Push **[BAND]** several times to select “GRP CQ” (CQCQCQ) “GRP UR” (UR call sign memories) and “CS” (current call sign).
  - The DV mode is automatically selected.

- ② Rotate **[DIAL]** to select the specific station call sign.

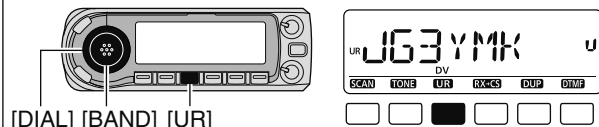

- ③ Push **[UR](DR)** to return to frequency indication mode.

- ④ Push and hold **[PTT]** to transmit and speak into the microphone at normal voice level.
  - “**TX**” appears and the RF meter shows the output power.
  - UR call sign is displayed and scrolled in sequence on the frequency display depending on “TX CS” setting (p. 136).

- ⑤ Release **[PTT]** to return to receive.
  - The other station’s call sign will be received.
  - Received call signs can be stored into the received call record automatically. See page 44 for details.

• **Current call sign setting example (Simplex call)**

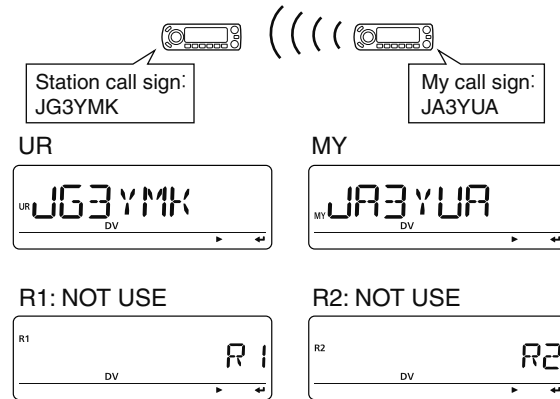

**NOTE:** The digital mode operation is vastly different from the FM mode. One of the differences is that in digital mode the squelch does not function as in the FM mode. Changing the squelch setting will not open it to hear the hiss of “white noise.” It only activates for digital squelch functions such as CSQ (Digital code squelch) or D SQL (Digital call sign squelch).

## ■ Repeater operation in the VFO

### ◇ Calling CQ in the same area (Area CQ)

- ① Set the desired repeater's frequency, offset and shift direction (pgs. 14, 15, 23, 27), then select the DV mode (p. 18).

Your own call sign (step ②) and station call sign (step ③) can also be set as same as repeater call signs in current call sign mode (step ④).

- ② Set the current MY call sign to your own call sign.
  - See pgs. 42, 43 for current call sign setting details.
- ③ Set the current station call sign as follows:
  - ➔ Push and hold **[UR]**(DR) for 1 sec. to enter UR call sign selection mode.
    - Push **[BAND]** several times to select "GRP CQ," then "CQCQCQ" is selected automatically. Push **[UR]**(DR) again.
- ④ Set the current repeater's call sign as follows:
  - ① Push **[CS]** to enter the current call sign mode.
    - UR call sign is displayed.
    - Push **[M/CALL]** to toggle the call sign and repeater name indications.
  - ② Rotate **[DIAL]** to select "R1," access repeater's call sign, then push **[←]**(MONI) to enter the current call sign selection mode.
  - ③ Rotate **[DIAL]** to select the desired access repeater's call sign, then push **[←]**(MONI) to set the call sign for "RPT1."
    - Return to the current call sign mode.

- ④ Rotate **[DIAL]** to select "R2," linked repeater's call sign, then push **[←]**(MONI) to set the current call sign selection mode.
    - "RPT2" call sign screen is displayed.
  - ⑤ Rotate **[DIAL]** to select "NOT USE," then push **[←]**(MONI).
    - Return to the current call sign mode.
  - ⑥ Push **[MENU]** to return to frequency indication.
- ⑤ Push **[PTT]** to transmit; release to receive.
    - "CQCQCQ" is displayed and scrolled in sequence on the frequency display depending on "TX CS" setting (p. 136).

### • Current call sign setting example

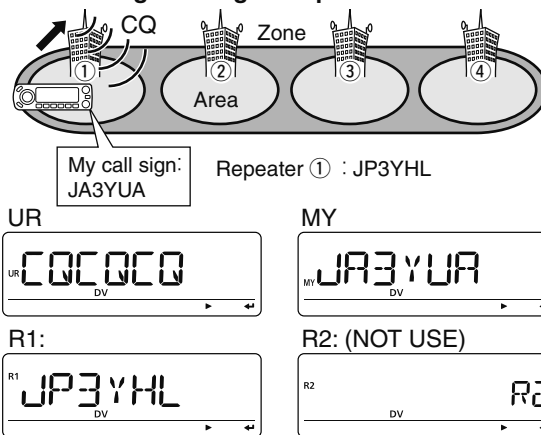

Pushing and holding **[BAND]** for 1 sec. selects the repeater group when in selection mode.

### ◇ Calling specific station in the same area (Area call)

- ① Set the desired repeater's frequency, offset and shift direction (pgs. 14, 15, 23, 27), then select the DV mode (p. 18).

Your own call sign (step ②) and station call sign (step ③) can also be set as same as repeater call signs in current call sign mode (step ④).

- ② Set the current MY call sign to your own call sign.  
• See pgs. 42, 43 for current call sign setting details.
- ③ Set the current station call sign as follows:
- ① Push and hold **[UR]**(DR) for 1 sec. to enter UR call sign selection mode.
  - ② Rotate **[DIAL]** to select the desired station call sign.  
• Push **[BAND]** several times to select "GRP UR" in advance.
  - ③ Push **[UR]**(DR) again to return to frequency indication.
- ④ Set the current repeater's call sign as follows:
- ① Push **[CS]** to enter the current call sign mode.  
• UR call sign is displayed.  
• Push **[M/CALL]** to toggle the call sign and repeater name indications.
  - ② Rotate **[DIAL]** to select "R1," access repeater's call sign, then push **[←]**(MONI) to enter the current call sign selection mode.
  - ③ Rotate **[DIAL]** to select the desired access repeater's call sign, then push **[←]**(MONI) to set the call sign for "RPT1."  
• Return to the current call sign mode.

- ④ Rotate **[DIAL]** select "R2," linked repeater's call sign, then push **[←]**(MONI) to set the current call sign selection mode.  
• "RPT2" call sign screen is displayed.
  - ⑤ Rotate **[DIAL]** to select "NOT USE," then push **[←]**(MONI).  
• Return to the current call sign mode.
  - ⑥ Push **[MENU]** to return to frequency indication.
- ⑤ Push **[PTT]** to transmit; release to receive.  
• UR call sign is displayed and scrolled in sequence on the frequency display depending on "TX CS" setting (p. 136).

#### • Current call sign setting example

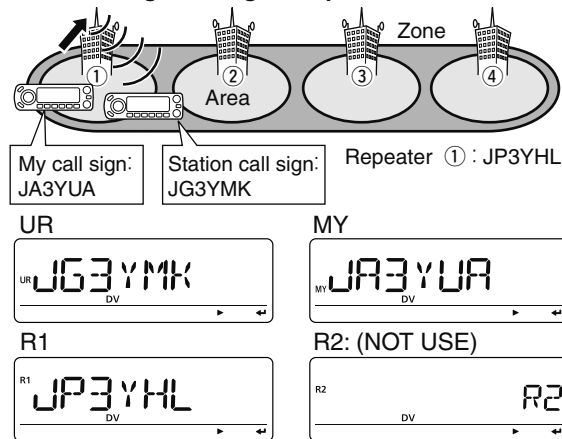

Pushing and holding **[BAND]** for 1 sec. selects the repeater group when in selection mode.

## 5 DV MODE OPERATION

### ◇ Calling CQ in the same zone (Zone CQ)

- ① Set the desired repeater's frequency, offset and shift direction (pgs. 14, 15, 23, 27), then select the DV mode (p. 18).

Your own call sign (step ②) and station call sign (step ③) can also be set as same as repeater call signs in current call sign mode (step ④).

- ② Set the current MY call sign to your own call sign.
  - See pgs. 42, 43 for current call sign setting details.
- ③ Set the current station call sign as follows:
  - ➔ Push and hold **[UR]**(DR) for 1 sec. to enter UR call sign selection mode.
    - Push **[BAND]** several times to select "GRP CQ," then "CQCQCQ" is selected automatically. Push **[UR]**(DR) again.
- ④ Set the current repeater's call sign as follows:
  - ① Push **[CS]** to enter the current call sign mode.
    - UR call sign is displayed.
    - Push **[M/CALL]** to toggle the call sign and repeater name indications.
  - ② Rotate **[DIAL]** to select "R1," access repeater's call sign, then push **[←](MONI)** to enter the current call sign selection mode.
  - ③ Rotate **[DIAL]** to select the desired access repeater's call sign, then push **[←](MONI)** to set the call sign for "RPT1."
    - Return to the current call sign mode.

Pushing and holding **[BAND]** for 1 sec. selects the repeater group when in selection mode.

- ④ Rotate **[DIAL]** to select "R2," linked repeater's call sign, then push **[←](MONI)** to set the current call sign selection mode.
    - "RPT2" call sign screen is displayed.
  - ⑤ Rotate **[DIAL]** to select the desired repeater call sign in the same zone, then push **[←](MONI)**.
    - Return to the current call sign mode.
  - ⑥ Push **[MENU]** to return to frequency indication.
- ⑤ Push **[PTT]** to transmit; release to receive.
    - "CQCQCQ" is displayed and scrolled in sequence on the frequency display depending on "TX CS" setting (p. 136).

### • Current call sign setting example

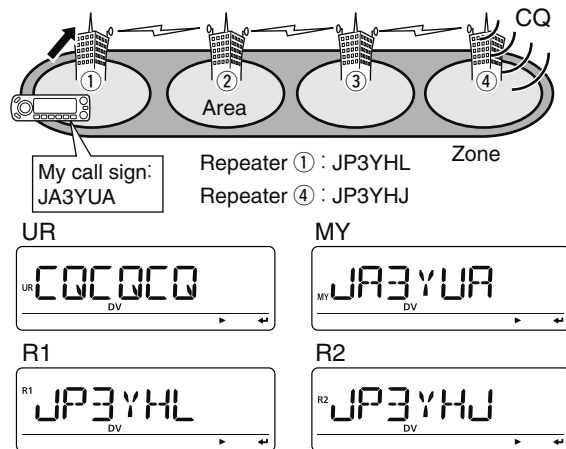

### ◇ Calling a specific station in the same zone (Zone call)

- ① Set the desired repeater's frequency, offset and shift direction (pgs. 14, 15, 23, 27), then select the DV mode (p. 18).

Your own call sign (step ②) and station call sign (step ③) can also be set as same as repeater call signs in current call sign mode (step ④).

- ② Set the current MY call sign to your own call sign.  
• See pgs. 42, 43 for current call sign setting detail.
- ③ Set the current station call sign as follows:
- ① Push and hold **[UR]**(DR) for 1 sec. to enter UR call sign selection mode.
  - ② Rotate **[DIAL]** to select the desired station call sign.  
• Push **[BAND]** several times to select "GRP UR" in advance.
  - ③ Push **[UR]**(DR) again to return to frequency indication.
- ④ Set the current repeater's call sign as follows:
- ① Push **[CS]** to enter the current call sign mode.  
• UR call sign is displayed.  
• Push **[M/CALL]** to toggle the call sign and repeater name indications.
  - ② Rotate **[DIAL]** to select "R1," access repeater's call sign, then push **[←]**(MONI) to enter the current call sign selection mode.
  - ③ Rotate **[DIAL]** to select the desired access repeater's call sign, then push **[←]**(MONI) to set the call sign for "RPT1."  
• Return to the current call sign mode.

- ④ Rotate **[DIAL]** to select "R2," linked repeater's call sign, then push **[←]**(MONI) to set the current call sign selection mode.  
• "RPT2" call sign screen is displayed.
  - ⑤ Rotate **[DIAL]** to select the desired repeater call sign in the same zone, then push **[←]**(MONI).  
• Return to the current call sign mode.
  - ⑥ Push **[MENU]** to return to frequency indication.
- ⑤ Push **[PTT]** to transmit; release to receive.  
• UR call sign is displayed and scrolled in sequence on the frequency display depending on "TX CS" setting (p. 136).

#### • Current call sign setting example

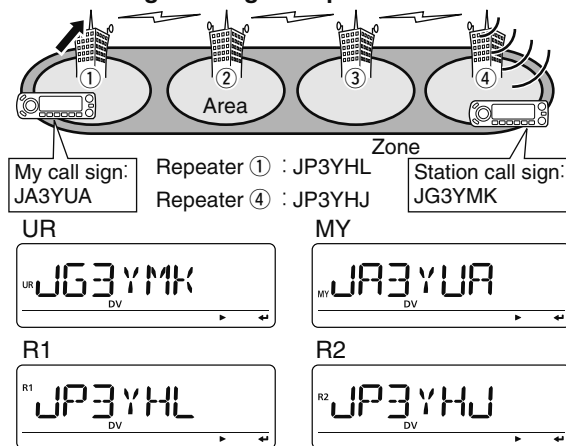

Pushing and holding **[BAND]** for 1 sec. selects the repeater group when in selection mode.

## 5 DV MODE OPERATION

### ◇ Calling CQ in another zone (Different zone CQ)

- ① Set the desired repeater's frequency, offset and shift direction (pgs. 14, 15, 23, 27), then select the DV mode (p. 18).
- ② Set the current MY call sign to your own call sign.
  - See pgs. 42, 43 for current call sign setting detail.
- ③ Set the current station call sign and repeater call signs as follows:
  - ① Push **[CS]** to enter the current call sign mode.
    - UR call sign is displayed.
    - Push **[M/CALL]** to toggle the call sign and repeater name indications.
  - ② Push **[←](MONI)** to enter the current call sign selection mode.
  - ③ Rotate **[DIAL]** to select the desired repeater call sign, then push **[←](MONI)** to set the call sign for "UR."
    - Return to the current call sign mode.
  - ④ Rotate **[DIAL]** to select "R1," access repeater's call sign, then push **[←](MONI)** to enter the current call sign selection mode.
  - ⑤ Rotate **[DIAL]** to select the desired access repeater's call sign, then push **[←](MONI)** to set the call sign for "RPT1."
    - Return to the current call sign mode.
  - ⑥ Rotate **[DIAL]** to select "R2," linked repeater's call sign, then push **[←](MONI)** to enter the current call sign selection mode.
    - "RPT2" call sign screen is displayed.

Pushing and holding **[BAND]** for 1 sec. selects the repeater group when in selection mode.

- ⑦ Rotate **[DIAL]** to select the specified gateway repeater call sign in the same zone, then push **[←](MONI)**.
    - Return to the current call sign mode.
  - ⑧ Push **[MENU]** to return to frequency indication.
- ④ Push **[PTT]** to transmit; release to receive.
    - UR call sign is displayed and scrolled in sequence on the frequency display depending on "TX CS" setting (p. 136).

#### • Current call sign setting example

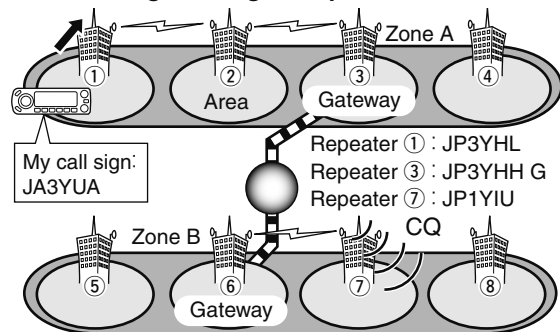

UR  
UR / JP 1YIU  
DV

MY  
MY JA3YUA  
DV

R1  
R1 JP3YHL  
DV

R2  
R2 JP3YHH G  
DV



### ◇ Calling a specific station in another zone (Different zone call)

- ① Set the desired repeater's frequency, offset and shift direction (pgs. 14, 15, 23, 27), then select the DV mode (p. 18).
- ② Set the current MY call sign to your own call sign.
  - See pgs. 42, 43 for current call sign setting detail.
- ③ Set the current station call sign and repeater call signs as follow;
  - ① Push **[CS]** to enter the current call sign mode.
    - UR call sign is displayed.
    - Push **[M/CALL]** to toggle the call sign and repeater name indications.
  - ② Push **[←](MONI)** to enter the current call sign selection mode.
  - ③ Rotate **[DIAL]** to select the desired station call sign, then push **[←](MONI)** to set the call sign for "UR."
    - Return to the current call sign mode.
  - ④ Rotate **[DIAL]** to select "R1," access repeater's call sign, then push **[←](MONI)** to enter the current call sign selection mode.
  - ⑤ Rotate **[DIAL]** to select the desired access repeater's call sign, then push **[←](MONI)** to set the call sign for "RPT1."
    - Return to the current call sign mode.
  - ⑥ Rotate **[DIAL]** to select "R2," linked repeater's call sign, then push **[←](MONI)** to enter the current call sign selection mode.
    - "RPT2" call sign screen is displayed.

Pushing and holding **[BAND]** for 1 sec. selects the repeater group when in selection mode.

- ⑦ Rotate **[DIAL]** to select the specified gateway repeater call sign in the same zone, then push **[←](MONI)**.
    - Return to the current call sign mode.
  - ⑧ Push **[MENU]** to return to frequency indication.
- ④ Push **[PTT]** to transmit; release to receive.
    - UR call sign is displayed and scrolled in sequence on the frequency display depending on "TX CS" setting (p. 136).

#### • Current call sign setting example

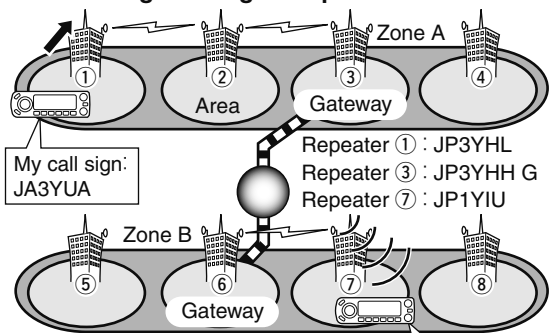

UR

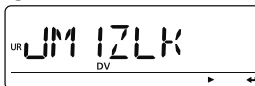

MY

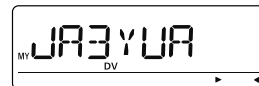

R1

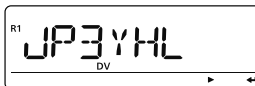

R2

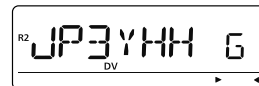

## 5 DV MODE OPERATION

### Message operation

#### ◇ TX message programming

TX messages are available for up to 5 channels and each channel can be programmed with a message of up to 20 characters.

- ① Enter "TX MSG" in MESSAG (message) screen.

MENU → MESSAG → **TX MSG**  
 (Push [MENU] (M)), (Rotate [DIAL]), then push [←] (MONI.)

• TX MSG screen is displayed.

- ② Rotate [DIAL] to select the desired transmit message channel.

• TM1 to TM5 and OFF are available.  
 • Previously message is displayed if programmed.

- ③ Push [▶] (LOW) to select the message edit condition.

• The 1st digit of the message blinks.

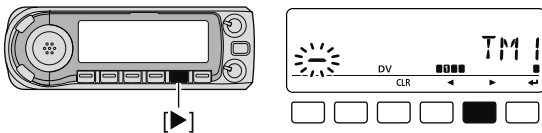

- ④ Rotate [DIAL] to select the desired character or symbol.

• If an unwanted character is entered, push [▶] (LOW) or [←] (CS) to select the character, then push [CLR] (DR) to erase the selected character, or push and hold [CLR] (DR) for 1 sec. to erase all characters following the cursor.  
 • Push [▶] (LOW) to move the cursor right; push [←] (CS) to move the cursor left.

- ⑤ Repeat the step ④ to enter the desired message.

• Up to 20 character messages can be set.

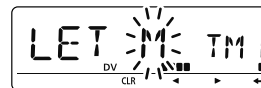

- ⑥ Push [←] (MONI) to store the message.

- ⑦ Push [MENU] (M) to return to frequency indication.

#### • Available characters

A	B	C	D	E	F	G	H	I	J	K	L	M
(A)	(B)	(C)	(D)	(E)	(F)	(G)	(H)	(I)	(J)	(K)	(L)	(M)
-----												
N	O	P	Q	R	S	T	U	V	W	X	Y	Z
(N)	(O)	(P)	(Q)	(R)	(S)	(T)	(U)	(V)	(W)	(X)	(Y)	(Z)
0	1	2	3	4	5	6	7	8	9	!	"	#
(0)	(1)	(2)	(3)	(4)	(5)	(6)	(7)	(8)	(9)	(!)	(")	(#)
\$	%	&	'	( )	( )	*	+	,	-	\	/	:
;	(%)	(&)	(')	( )	( )	(*)	(+)	(,)	(-)	(\)	(/)	(:)
-----												
/	<	=	>	?	@	[	\	]	^	_ (Space)		
(/)	(<)	(=)	(>)	(?)	(@)	([)	(\)	(])	(^)	(Space)		

## ◇ Message Transmission

You can toggle the message transmission function ON (TM1–TM5) and OFF. When a message channel is selected, the transceiver transmits a pre-programmed text message. (default: OFF)

- ① Set the operating frequency, call signs and other settings, such as repeater operation, as desired.
- ② Enter "TX MSG" in MESSAG (message) screen.

MENU ⇨ MESSAG ⇨ **TX MSG**  
(Push **[MENU]**), (Rotate **[DIAL]**, then push **[←]**(MONI).)

- TX MSG screen is displayed.
- ③ Rotate **[DIAL]** to select the desired transmit message channel.
    - TM1 to TM5 are available.
  - ④ Push **[←]**(MONI) to set the message for transmission.
  - ⑤ Push **[PTT]** to transmit.
    - The message is transmitted each time when **[PTT]** is pushed.
    - The message is transmitted each 30 sec. automatically during continuous transmission.
  - ⑥ Release **[PTT]** to return to receive.

- ⑦ When the reply call with a message is received, the call sign and the message scrolls at the frequency display.

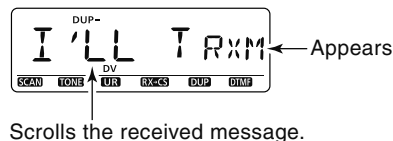

### ✓ For your information

The automatic received call sign and/or message indication can be turned OFF in the DV SET mode, if desired.

- ➡ RX CS (RX call sign) (p. 136)
- ➡ RX MSG (RX message) (p. 136)

**NOTE:** Only one message can be stored in the ID-880H. The received message is cleared by turning power OFF, or overwritten when another message is received.

## 5 DV MODE OPERATION

### ◇ RX message indication

The received message can also be checked in MESSAG (message) screen.

- ① Select "RX MSG" in MESSAG (message) screen.

MENU ⇨ MESSAG ⇨ **RX MSG**  
(Push [MENU ]), (rotate [DIAL], then push [←](MONI).)

- The received message is displayed.
- Push [▶](LOW) or [◀](CS) to scroll the message.

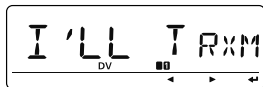

- ② Rotate [DIAL] to display the station call sign (caller).

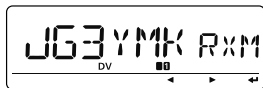

- ③ Push [←](MONI) several times to return to RX MSG screen.  
• Push [▶](LOW) or [◀](CS) to scroll the call sign.
- ④ Push [MENU ] to return to frequency indication.

## ■ Automatic reply function

The automatic reply function replies to calls by a station that specified your call sign.

### ◇ Automatic reply function setting

- ① Enter "REPLY" in the DV SET mode.

MENU ⇨ DV SET ⇨ **REPLY** (p. 134)  
(Push [MENU ]), (rotate [DIAL], then push [←](MONI).)

- REPLY (auto reply) screen is displayed.

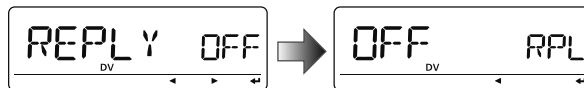

- ② Rotate [DIAL] to turn the automatic reply function ON or OFF.  
**OFF**: Deactivate the automatic reply function. (default)  
**ON** : Reply to the call with your own call sign.
- ③ Push [←](MONI).  
• Returns to the DV SET mode automatically.
- ④ Push [MENU ] to return to frequency indication.

/// The Automatic replay function is turned OFF automatically, when a manual transmission (pushing [PTT]) is performed.

## ■ EMR communication

The EMR (Enhanced Monitor Receive) communication mode is available for digital mode operation. In the EMR communication mode, no call sign setting is necessary. When an EMR communication mode signal is received, the audio (voice) will be heard at the specified level even if the volume setting level is set to minimum level, or digital call sign/digital code squelch is in use.

- ① Enter "EMR" in the DV SET mode.

MENU ⇄ DV SET ⇄ **EMR**  
(Push [MENU], (rotate [DIAL], then push [←](MONI).)

- EMR screen is displayed.

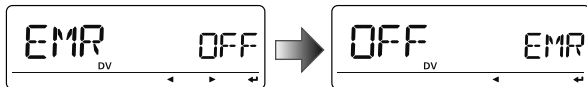

- ② Rotate [DIAL] to turn the EMR communication mode ON or OFF.

**OFF** : EMR communication is set OFF. (default)

**ON** : EMR communication is set ON.

- When "ON" is selected, "EMR" appears instead of memory channel indication.

- ③ Push [←](MONI).

- Returns to the DV SET mode.

- ④ Push [MENU] to return to frequency indication.



- ⑤ Push [PTT] to transmit.

- ⑥ Release [PTT] to return to receive.

**NOTE:** The EMR communication function is turned OFF automatically when turning transceiver's power OFF

## 5 DV MODE OPERATION

### ■ Break-in communication

The break-in function allows you to break into a conversation, where the two original stations are communicating with call sign squelch enabled.

- ① While receiving an another station's communication, push and hold **[RX→CS]**(CS) for 1 sec. to set the communicating station's call sign.
  - When a call sign has not been received correctly, error beeps sound and no call sign is set. Try to set the call sign of a communicating signal again, or set the call sign manually.
- ② Enter "BK" in the DV SET mode.

MENU ⇨ DV SET ⇨ **BK**  
(Push **[MENU]**), (rotate **[DIAL]**, then push **[←]**(MONI).)

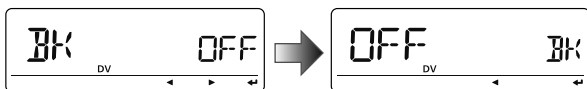

- BK screen is displayed.
- ③ Rotate **[DIAL]** to turn the Break-in function ON or OFF.
    - When "ON" is selected, "BK" appears instead of memory channel indication
  - ④ Push **[←]**(MONI).
    - Returns to the DV SET mode.

- ⑤ Push **[MENU]** to return to frequency indication.



- ⑥ When both stations are in standby, push **[PTT]** to transmit a break-in call.
  - The programmed call sign station receives the break-in call as well as your call sign.
- ⑦ Wait for the reply call from the station who receives the break-in call.
- ⑧ After receiving the reply call, communicate normally.
- ⑨ To cancel the break-in function, turn the Break-in function OFF in the DV SET mode as steps ② to ⑤.

**NOTE:** The break-in function is turned OFF automatically when turning transceiver's power OFF

### • How to use break-in?

While operating with the digital call sign squelch (p. 151), the squelch never opens (no audio sounds) even if a call is received, unless your own call sign (“MY”) is specified.

However, when the call including the “BK ON” signal (break-in call) is received, the squelch will open and audio sounds even if the call is specified for another station.

#### • Station C calling to Station A with “BK OFF”

Station A and B are communicating using the digital call sign squelch.

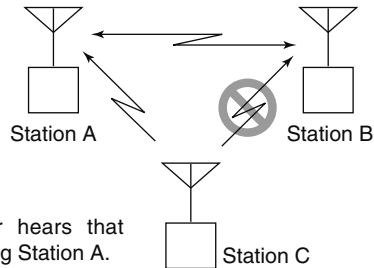

Station B never hears that Station C is calling Station A.

#### • Station C calling to Station A with “BK ON”

Station A and B are communicating using the digital call sign squelch.

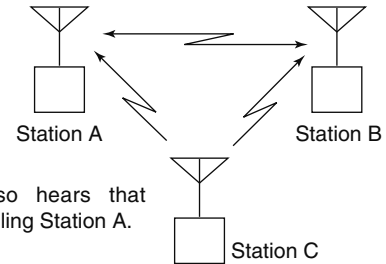

Station B also hears that Station C is calling Station A.

### ■ Low-speed data communication

In addition to the digital voice communication, low-speed data communication is available.

Use the optional OPC-1529R DATA COMMUNICATION CABLE with third-party serial data communication software.

/// **NOTE:** Turn OFF "GPS-TX" (p. 138) in advance to operate the low-speed data communication.

#### ◇ Connection

Connect the transceiver to your PC using with the optional OPC-1529R as illustrated below.

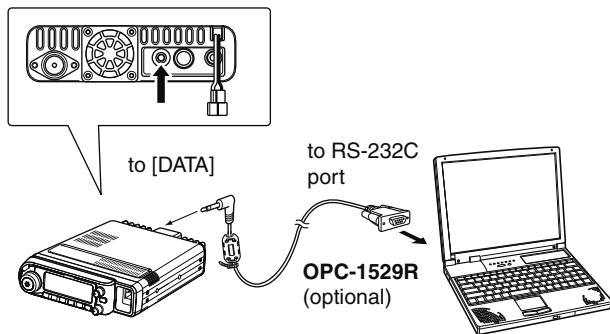

#### ◇ Low-speed data communication application setting

Configure the serial data communication software as follows.

- Port : The COM port into which you plugged the OPC-1529R
- Baud rate : 9600/4800 bps (p. 130)
- Data : 8 bit
- Parity : None
- Stop : 1 bit
- Flow control : Xon/Xoff

#### ◇ Low-speed data communication operation

/// **NOTE:** Confirm that when in AUTO, the computer controls [PTT] to send data. In AUTO you should not have to push [PTT] to send data.

- ① Set the current call signs, etc. as described in "Current call sign setting" (p. 42), "Simplex operation in the VFO" (p. 56) and "D-STAR repeater operation in the VFO" (p. 58).
- ② Follow the instructions for the data communication software.
- ③ To transmit data
  - At the same time as your voice audio, push and hold [PTT] to transmit while sending data from the PC. Release [PTT] to receive.
  - Under computer control, see Transmission condition setting at right.



### ◇ Transmission condition setting

- ① Enter "DATATX" in the DV SET mode.

MENU ⇨ DV SET ⇨ **DATATX**  
(Push [MENU ]), (rotate [DIAL], then push [←](MONI).)

- ② Rotate [DIAL] to select "PTT" or "AUTO."
- PTT** : The input data from [DATA] are transmitted when pushing [PTT]. (default)
- AUTO** : The input data from [DATA] are transmitted automatically when the data are input.
- ③ Push [←](MONI) to return to the DV SET mode, and push [MENU ] to return to frequency indication.

## 5 DV MODE OPERATION

### ■ Other functions in the DV mode

#### ◇ DV auto detect

The “DV” mode indicator and “FM” mode indicator blink when a non-DV signal is received during DV mode operation. When a signal other than the DV mode is received, the ID-880H DV automatic detection switches to monitor in the FM mode.

- ① Enter “DV DET” in the DV SET mode.

MENU ⇨ DV SET ⇨ **DV DET** (p. 135)  
(Push [MENU], (rotate [DIAL], then push [←](MONI).)

- ② Rotate [DIAL] to turn the DV automatic detect function ON or OFF.

**OFF** : “DV” blinks then “FM” also blinks, but the transceiver receives in the DV mode even if non-DV mode signals are received.

**ON** : “DV” blinks then “FM” also blinks when the transceiver monitors the receiving signal other than the DV mode, the signal is in the FM mode.

- ③ Push [←](MONI) to return to the DV SET mode.
- ④ Push [MENU] to return to frequency indication.

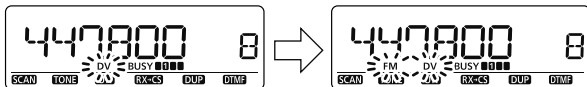

**NOTE:** The received FM audio may be distorted when receiving an FM signal with DV automatic detect function.

#### ◇ Packet loss indication

While operating voice communication or low-speed data communication via the internet network from one zone to another zone, some packets may be lost due to network error (poor data throughput performance). In such a case, the ID-880H displays “P-LOSS” instead of frequency indication on the display to indicate Packet Loss has occurred.

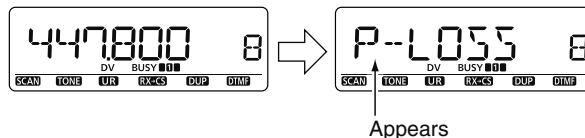

## ■ GPS operation

You can display GPS data when in FM, FM-N, WFM, AM and DV\* modes. You can also transmit GPS data when in DV mode. To receive GPS data, connect a third-party GPS receiver that has an RS-232C output and NMEA data format. Third-party GPS receivers connect to the ID-880H [DATA] jack.

In addition, the GPS message transmission is also available in GPS mode operation.

\*Set "GPS-TX" to "DVG" or "DVA" at step ② of next page if you want to use a 3rd party GPS receiver in DV mode.

### • When connecting the GPS receiver

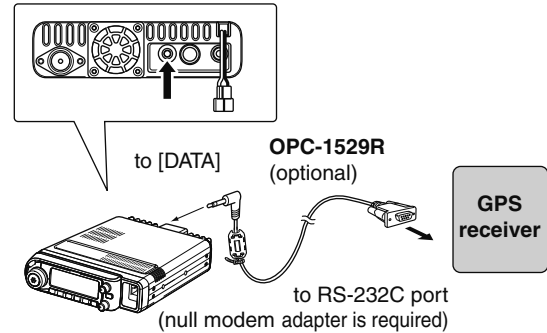

## 6 GPS/GPS-A OPERATION

### ◇ Sentence formatter setting

- ① Enter “GPS-TX” in GPS mode.

MENU ⇨ GPS ⇨ **GPS-TX**  
(Push [MENU ]), (rotate [DIAL], then push [←](MONI).)

- GPS-TX screen is displayed.

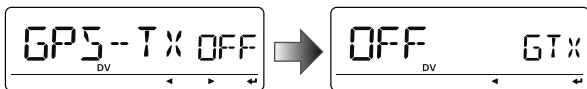

- ② Rotate [DIAL] to select “DVG.”
- ③ Push [←](MONI) to select GPS sentence screen.
- ④ Rotate [DIAL] to select the desired GPS sentence, then push [←](MONI).
- A total of 6 sentences, RMC, GGA, GLL, GSA, VTG and GSV are available.
- ⑤ Rotate [DIAL] to select to turn the sentence usage ON or OFF.
- ⑥ Push [←](MONI) to return to GPS sentence screen.
- ⑦ Repeat the steps ④ to ⑥ to set another GPS sentence usage.
- Up to 4 GPS sentences are usable at the same time.
- ⑧ Push [MENU ] to return to frequency indication.

#### NOTE:

Set the GSV sentence to OFF when sending the GPS message to conventional digital transceivers (IC-2820H, ID-800H, IC-91AD, IC-V82, IC-U82, IC-2200H). The GSV sentence is incompatible with them. Those transceivers will not display GPS messages properly if sent as a GSV sentence from the ID-880H.

### ◇ GPS message programming

- ① Enter “TX GPS” in MESSAG screen.

MENU ⇨ MESSAG ⇨ **TX GPS**  
(Push [MENU], (rotate [DIAL], then push [←](MONI).)

- TX GPS screen is displayed.

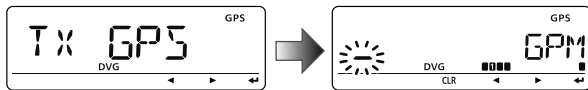

- ② Push [←](MONI) to select the message edit condition.  
• The 1st digit of the message blinks.
- ③ Rotate [DIAL] to select the desired character or symbol.
- ④ Push [▶](LOW) to select 2nd digit, then rotate [DIAL] to select the desired character or code.  
• Push [▶](LOW) to move the cursor right; push [◀](CS) to move the cursor left.  
• 2nd digit blinks (1st digit stops blinking).
- ⑤ Repeat step ④ to enter the desired message.  
• Up to 20-character messages can be set.

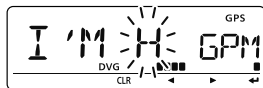

- ⑥ Push [←](MONI) to store the message.
- ⑦ Push [MENU] to return to frequency indication.

### ◇ GPS message automatic transmission

- ① Enter “GPS.ATX” in GPS mode.

MENU ⇨ GPS ⇨ **GPS.ATX** (p. 141)  
(Push [MENU], (rotate [DIAL], then push [←](MONI).)

- GPS AUTO TX screen is displayed.

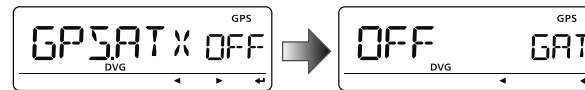

- ② Rotate [DIAL] to select the desired position data transmitting interval from 5 sec., 10 sec., 30 sec., 1 min., 3 min., 5 min., 10 min., 30 min. or OFF.  
• The GPS message is also transmitted if programmed.
- ③ Push [←](MONI) to return to GPS mode.
- ④ Push [MENU] to return to frequency indication.

/// **NOTE:** Your own call sign (“MY”) must be set to activate the GPS automatic transmission.

#### [NOTICE]

“5SEC” cannot be selected when 4 GPS sentences are selected.

- /// Only use GPS message automatic transmission in simplex mode.
- /// Automatic GPS message transmission through a repeater may interfere with other communications.

## 6 GPS/GPS-A OPERATION

### ◇ Received GPS message indication

- ① Enter "RX GPS" in MESSAG screen.

MENU ⇨ MESSAG ⇨ **RX GPS**  
(Push [MENU ]), (rotate [DIAL], then push [←](MONI).)

- RX GPS screen is displayed.

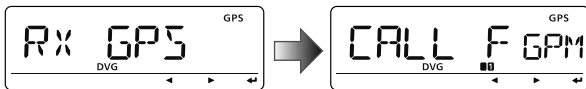

- ② Push [←](MONI) several times to scroll the message.  
③ Push [←](MONI) to return to the MESSAG screen.  
④ Push [MENU ] to return to frequency indication.

### ◇ Position indication

- ① Enter "GPS.POS" in GPS mode.

MENU ⇨ GPS ⇨ **GPS.POS**  
(Push [MENU ]), (rotate [DIAL], then push [←](MONI).)

- GPS POS screen is displayed.

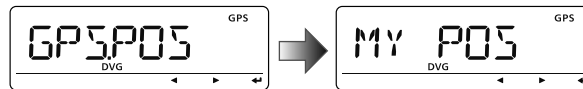

- ② Rotate [DIAL] to select the position data indication.
- **MY POS** : Displaying own latitude and longitude.
  - **RX POS** : Displaying (caller) other station latitude and longitude.
  - **ELEVAT** : Displaying own elevation.
  - **TIME** : Displaying the time.
  - **DISTAN** : Displaying distance from (caller) other station.
  - **CALLER** : Displaying the call sign of (caller) other station.
- ③ Push [←](MONI) to enter the selection.  
④ Push [←](MONI) to return to the "GPS.POS" screen. See "MY POS" and "RX POS" operations at next page.
  - "CALLER" indication also scrolls.
- ⑤ Push [MENU ] to return to frequency indication.

**NOTE:** Depending on the receiving conditions of the GPS signals, your position/elevation may change even though you are stationary.

• **Selectable items**

My position

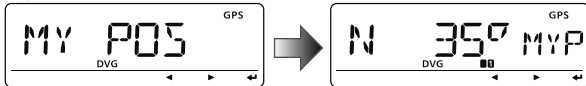

Received position

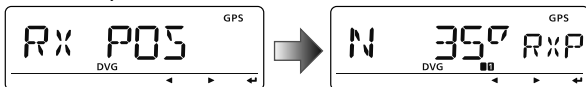

Elevation

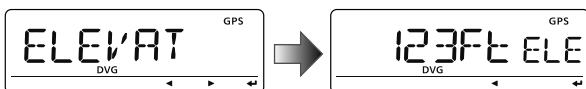

Time

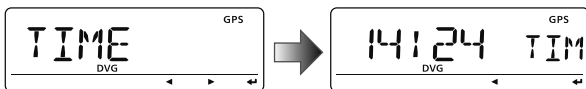

Distance

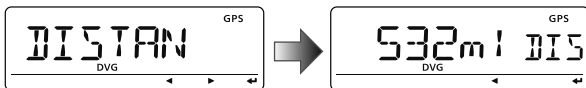

Caller

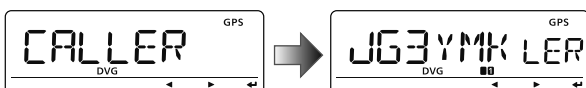

• **Position indication**

My position

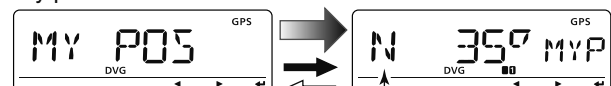

North or South

My position  
35°45.00'N  
135°35.00'E



S/R/F meter indicates the selection

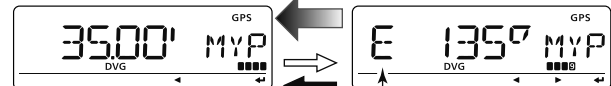

East or West

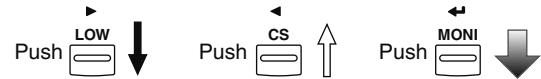

Depending on the connected GPS receiver, "TIME" indication is not available.

These sample indications assume that "P FORM" is selected "mm.mm" and "UNITS" is selected "Ft/mi." (p. 138)

## 6 GPS/GPS-A OPERATION

### ◇ Saving own/received position data

① Enter “GPS.POS” in GPS mode.

MENU ⇨ GPS ⇨ **GPS.POS**  
(Push [MENU] ), (rotate [DIAL], then push [←](MONI).)

• GPS POS screen is displayed.

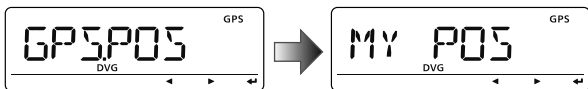

② Rotate [DIAL] to select the position data indication.

- **MY POS** : Displaying own latitude and longitude.
- **RX POS** : Displaying (caller) other station latitude and longitude.

③ Push [←](MONI) to enter the selection.

④ Push and hold [MW](S.MW) for 1 sec. to save the selected position data to GPS memory (G00).

- The M-CH number advances automatically in case the next M-CH already contains information.
- 50 GPS M-CH are available.
- Push [M/CALL] to display stored position data.

### ◇ Displaying direction and forward

Displaying own direction, received station's direction and set position and direction in the GPS memory.

① Enter “D/F” in GPS mode.

MENU ⇨ GPS ⇨ **D/F**  
(Push [MENU] ), (rotate [DIAL], then push [←](MONI).)

• D/F (Direction/Forward) screen is displayed.

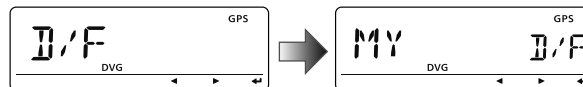

② Rotate [DIAL] to select “RX,” “MY” and “GPS.M”

#### [Indication items]

- **MY** : Displays own direction, elevation and the time.
- **RX** : Displays other station's direction and distance from own position.
- **GPS.M** : Displays the direction and distance from own position of alarm setting for the memorized position in the GPS memory.

③ Push [←](MONI) to enter the selection.

- 16 compass points are available.

④ Push [←](MONI) several times to select other information.

⑤ Push [MENU] to return to frequency indication.



• Direction indication example

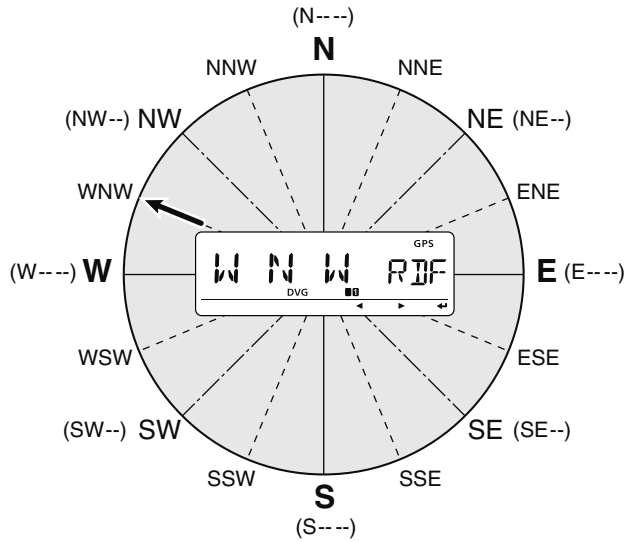

MY



RX



GPS.M



## 6 GPS/GPS-A OPERATION

### ◇ GPS data addition

- ① Enter “GPS.MEM” (GPS memory) in GPS mode.

MENU → GPS → **GPS.MEM**  
(Push [MENU], (rotate [DIAL], then push [←](MONI).)

- GPS memory selection screen is displayed.

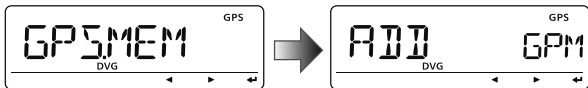

- ② Push [←](MONI) to enter the new GPS memory channel programming state.
- ③ Rotate [DIAL] to select the desired items, “NAME,” “TIME,” “LAT” (LATITUDE) or “LON” (LONGITUDE), then push [▶](LOW) to edit the selected item.

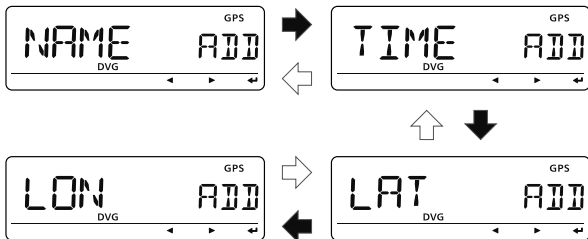

- ④ Rotate [DIAL] to select the desired character or number.

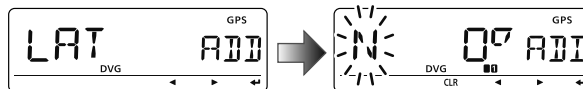

- Push [▶](LOW) to move the cursor right; push [←](CS) to move the cursor left.
- ⑤ Repeat step ④ to enter the desired latitude data, then push [←](MONI) to program the item.
- ⑥ Repeat steps ③ to ⑤ to program the other items.
- The name may contain up to 6 characters.
- ⑦ Push [←](MONI) to store the GPS data.
- ⑧ Push [MENU] to return to frequency indication.

## ◇ GPS alarm setting

GPS alarm sounds when your own position is close the specified position. This function can be set to use information from the received channel, a specified GPS memory channel or all GPS memory channels.

- ① Enter “ALM-CH” in GPS mode.

MENU ⇨ GPS ⇨ **ALM-CH**  
(Push [MENU], (rotate [DIAL], then push [←](MONI).)

- Alarm setting screen is displayed.

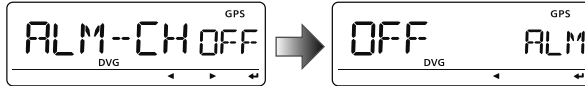

- ② Rotate [DIAL] to select “RX,” “CH,” “ALL” or “OFF.”

- “RX,” “ALL,” one of the memory channel can be selected.
- Skip next step ③ when RX, ALL or OFF is selected.

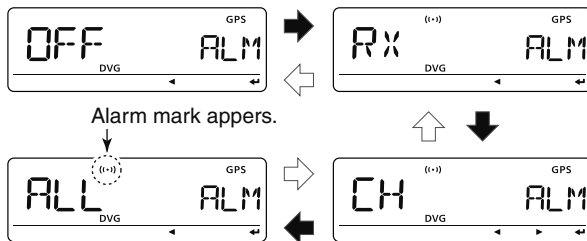

- ③ Push [←](MONI), then rotate [DIAL] to select the desired memory channel.
- Memory name or channel number appears when the channel is selected.



- ④ Push [←](MONI) to set the alarm function and return to ALM-CH (GPS memory) screen.
- ⑤ Push [MENU] to return to frequency indication.

### ✓ For your information!

- When “ALL” is selected in step ②, the alarm function depends on “ALM1” setting in GPS mode (p. 84).
- When “RX” or “CH” is selected in step ②, the alarm function depends on “ALM2” setting in GPS mode (p. 85).

## 6 GPS/GPS-A OPERATION

### ◇ GPS alarm setting in GPS memory channel

GPS alarm setting for a specified GPS memory channel is available on GPS memory channel indication.

- ① Enter "GPS.MEM" in GPS mode.

MENU ⇨ GPS ⇨ **GPS.MEM**

(Push [MENU] ()), (rotate [DIAL], then push [←] (MONI).)

- GPS memory selection screen is displayed.

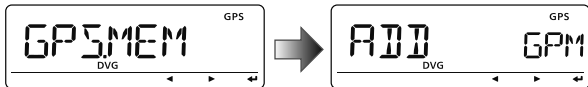

- ② Rotate [DIAL] to select the desired memory channel.

- Memory name or channel number appears when the channel is selected.

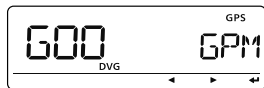

- ③ Push [M/CALL] to switch the alarm function ON or OFF.

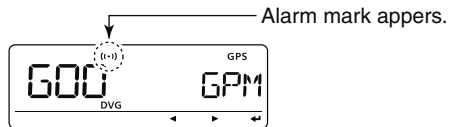

- ④ Push [←] (CS) to return to GPS.MEM (GPS memory) screen.  
⑤ Push [MENU] ( ) to return to frequency indication.

### ✓ For your information!

- When the alarm setting is set to a memory channel, the alarm function depends on "ALM2" setting in GPS mode (p. 84).

## ◇ GPS memory clearing

### • Clear all memory channels

- ① Enter “GPS.MEM” in GPS set mode.

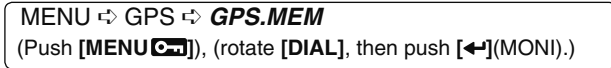

- GPS memory selection screen is displayed.

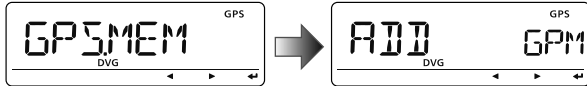

- ② Rotate [DIAL] to select “CLEAR ALL,” then push [←](MONI).

- “CLEAR OK?” appears.

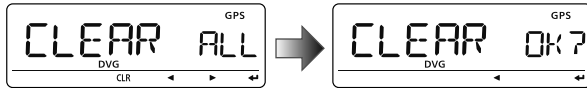

- ③ Push [←](MONI) again to clear all memory channels.
- 2 beep sounds, then all memory channels are cleared.
  - Push and hold [CLR](DR) for 1 sec. also clears all memory channels when “CLEAR ALL” is displayed.
- ④ Push [←](CS) to return to GPS.MEM (GPS memory) screen.
- ⑤ Push [MENU] to return to frequency indication.

### • Clear desired memory channel to be cleared

- ① Enter “GPS.MEM” in GPS set mode as described at left.
- ② Rotate [DIAL] to select the desired GPS memory channel to be cleared.

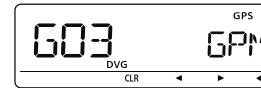

- ③ Push and hold [CLR](DR) for 1 sec. to clear the list.
- 2 beep sounds, then the selected memory channel is cleared.
  - Remaining channels scroll up.



- ④ Push [←](CS) to return to GPS.MEM (GPS memory) screen.
- ⑤ Push [MENU] to return to frequency indication.

## 6 GPS/GPS-A OPERATION

### ◇ Alarm area 1

Sets GPS alarm active range from 00.08' to 59.99' in 00.01' steps. (default: 00.25')

① Enter "ALM1" in GPS set mode.

MENU → GPS → **ALM1**  
(Push [MENU] ), (rotate [DIAL], then push [←](MONI).)

• ALM1 setting screen is displayed.

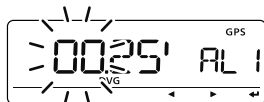
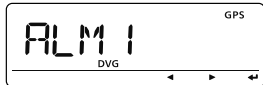

When "P FORM" (position format) (p. 138) is selected "mm.mm."

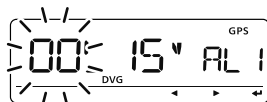

When "P FORM" (position format) (p. 138) is selected "mm.SS."

② Rotate [DIAL] to set the desired alarm area.

• Push [▶](LOW) to move the cursor right; push [◀](CS) to move the cursor left.

③ Push [←](MONI) to set the area.

④ Push [MENU] to return to frequency indication.

/// The alarm area 1 function is available when the "GPS ALARM" function ALL is ON.

• **Example:** Your position : 35°N/135°E  
ALM AREA1 setting : 00.25' (default)

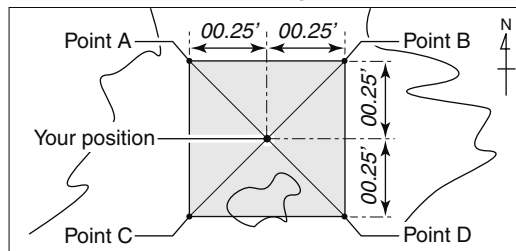

- Position of point A : 35°00.25'N/134°59.75'E
- Position of point B : 35°00.25'N/135°00.25'E
- Position of point C : 34°59.75'N/134°59.75'E
- Position of point D : 34°59.75'N/135°00.25'E

When the target position comes into the alarm area shown above, the GPS alarm sounds.

These sample indications assume that "P FORM" is selected "mm.mm." (p. 138)

## ◇ Alarm area 2

Selects GPS alarm active range from “BOTH,” “EXTEND” and “LIMIT” when “CH” or “RX” is selected at GPS alarm setting.

① Enter “ALM2” in GPS mode.

MENU → GPS → **ALM2**  
(Push [MENU], (rotate [DIAL], then push [←](MONI).)

• ALM2 setting screen is displayed.

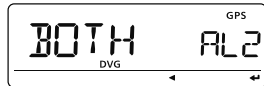
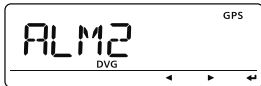

② Rotate [DIAL] to select the desired alarm setting, then push [←](MONI) to set.

- **BOTH** : GPS alarm<sup>†</sup> will sound when a target position enters both 500 m\* (547 Y)\* and 1 km\* (1094 Y)\* range. (default)
- **EXTEND** : GPS alarm<sup>†</sup> will sound when a target position enters 1 km\* (1094 Y)\* range.
- **LIMITE** : GPS alarm<sup>†</sup> will sound when a target position enters 500 m\* (547 Y)\* range.

\*Approximate

<sup>†</sup> One beep sounds when coming within 1 km (1094 Y) and three beeps when coming within 500 m (547 Y).

<sup>‡</sup> Three beep sounds.

③ Push [MENU] to return to frequency indication.

• **Example:**

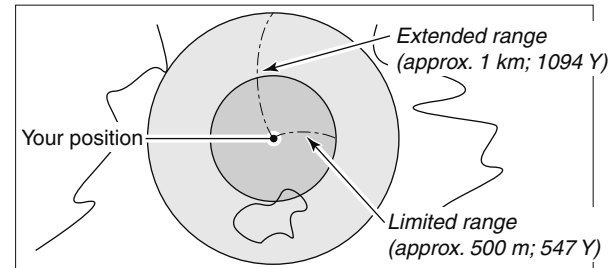

The target position definitions for Alarm area 2.

### Alarm indication

When a target position comes into the alarm area, below indication appears.



Shows above indications alternately.

- Push any key to return to frequency indication, but “(·)” indicator continues to blink in the area.

### ■ GPS-A operation

#### ◇ GPS-A function

Set the following to activate the GPS-A function.

- ① Select the DV mode operation (p. 18)
- ② Select "GPS-TX" (GPS transmission mode) to DVA.  
(p. 138)
- ③ Set "GPS.ATX" (GPS auto transmission timer). (p. 141)
- ④ Set the GPS-A set items. (pgs. 139–141)

#### ◇ GPS-A code details

In GPS-A operation, the following codes are transmitted to the PC connected to the ID-880H. GPS-A code is based on APRS® code. (APRS® : Automatic Position Reporting System)

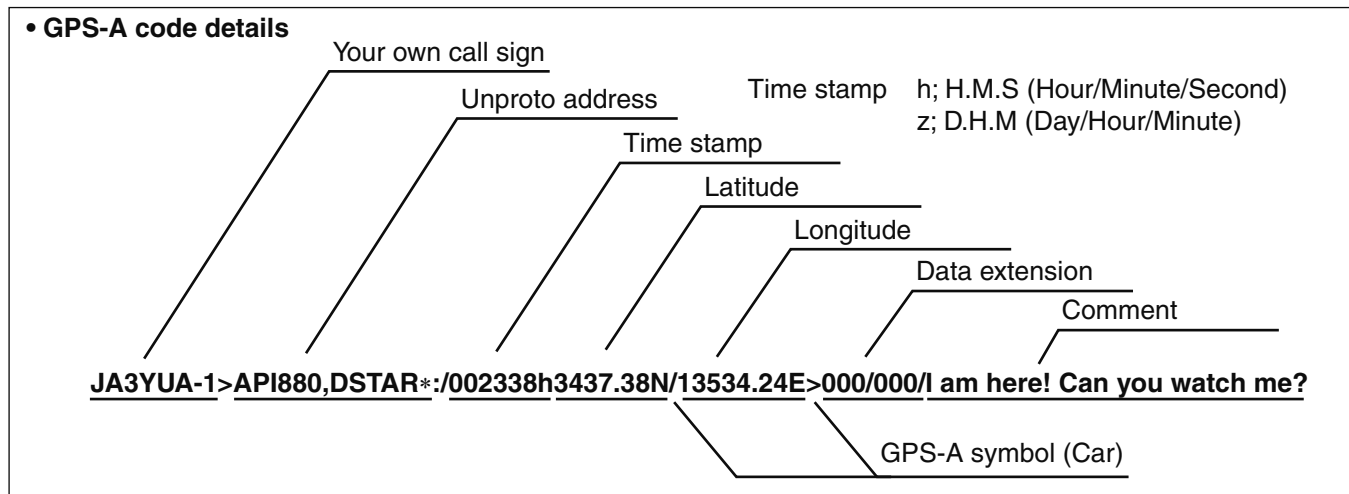



## ■ General description

The transceiver has 1050 memory channels, and 2 call channels. Memory channels include 50 scan edge memory channels (25 pairs) for storage of often-used frequencies.

Also, 26 memory banks, A to Z, are available in each band for storing groups of frequencies, etc. Up to 100 channels can be assigned to a bank.

### ◇ Memory channel contents

The following information can be programmed into memory channels:

- Operating frequency (pgs. 14, 15)
- Operating mode (p. 18)
- Duplex direction (+DUP or -DUP) with a frequency offset (p. 23)
- Subaudible tone encoder (p. 23), tone squelch or DTCS squelch ON/OFF (p. 146)
- Subaudible tone frequency (p. 25), tone squelch frequency or DTCS code with polarity (pgs. 147–149)
- Scan skip information (p. 108)
- Memory bank (p. 92)
- Memory name (p. 94)
- Tuning step (p. 15)
- Call sign squelch or Digital code squelch (p. 151)
- Station call sign (p. 32)
- RPT1/RPT2 call sign (p. 33)

#### NOTE:

Memory data can be erased by static electricity, electric transients, etc.

In addition, they can be erased by malfunction and during repairs.

Therefore, we recommend that memory data be written down or be saved to a PC using the CS-80/880 CLONING SOFTWARE (free download software).

## ■ Selecting a memory channel

### ◇ Using the tuning dial

- 1 Push **[M/CALL]** several times to select the memory mode.
  - “**MR**” indicator appears.
- 2 Rotate **[DIAL]** to select the desired memory channel.
  - Only programmed memory channels can be selected.

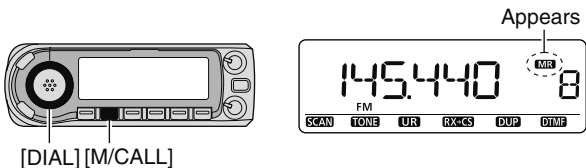

### ◇ Using the [▲]/[▼] keys



- 1 Push **[MR/CALL]** to select the memory mode.
- 2 Push **[▲]** or **[▼]** to select and set the desired memory channel.
  - Pushing and holding **[▲]/[▼]** for 1 sec. activates a scan.
  - If scan is activated, push **[▲]/[▼]** again or push **[CLR A(MW)]** to stop it.

### ◇ Using the keypad

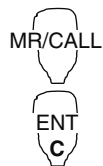

- 1 Push **[MR/CALL]** to select the memory mode.
- 2 Push **[ENT C(T-OFF)]** to activate the keypad for numeral input.
- 3 Push 3 appropriate digit keys to input a channel number.
  - Blank channel can be selected.
  - Push only 1 or 2 appropriate digit key(s), **[VOL▲ 0(TONE-2)]** to **[SIMP 9(16-KEY-L)]** then push **[VOL▼ \*(TONE-1)]** or **[SQL▼ #(16KEY-L)]** to select scan edge channels. “\*” and “#” can be used for “A” and “B” respectively.

## ■ Selecting a call channel

Call channel is a pre-programmed memory channel that can be accessed by simply pushing call channel button.

- ➔ Push **[M/CALL]** several times to select the call channel mode, then rotate **[DIAL]** to select the desired call channel.
  - “C0” or “C1” appears instead of memory channel number.

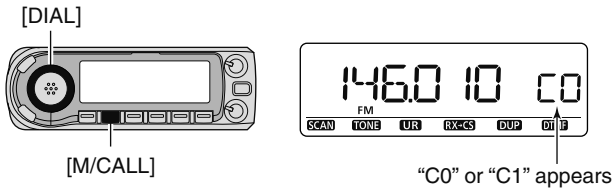

- ➔ Push and hold **[MR/CALL]** for 1 sec. to select the call channel mode then push **[▲]/[▼]** to select the desired call channel in the main band.
  - Push **[MR/CALL]** to select the memory mode, or push **[VFO/LOCK]** to select the VFO mode.

## Memory channel programming

- ① Push **[VFO/MHz]** to select the VFO mode.
- ② Set the desired frequency:
  - ➔ Select the desired band with **[BAND]**.
  - ➔ Set the desired frequency with **[DIAL]**.
  - ➔ Set other data (e.g. frequency offset, duplex direction, tone squelch, current call signs, etc.), if desired.
- ③ Push **[S.MW]** to enter the select memory write mode.
  - “**MIR**” indicator and the memory channel number blink.
- ④ Rotate **[DIAL]** to select the desired channel.
  - Call channels (C0, C1), VFO and scan edge channels (0A/0B to 24A/24B), as well as regular memory channels, can be programmed in this way.
- ⑤ Push and hold **[MW]**(S.MW) for 1 sec. to program.
  - 3 beeps sound.
  - Memory channel number automatically increases when continuing to push **[MW]**(S.MW) after programming.

**NOTE:** Push **[MENU]** to cancel to program and exit the select memory write mode before memory programming is finished.

### ✓ FOR YOUR CONVENIENCE

Memory programming can be performed in various ways e.g. memory channel to the different memory channel, memory channel to the call channel, etc.

**[EXAMPLE]:** Programming 145.870 MHz into memory channel 20 (blank channel).

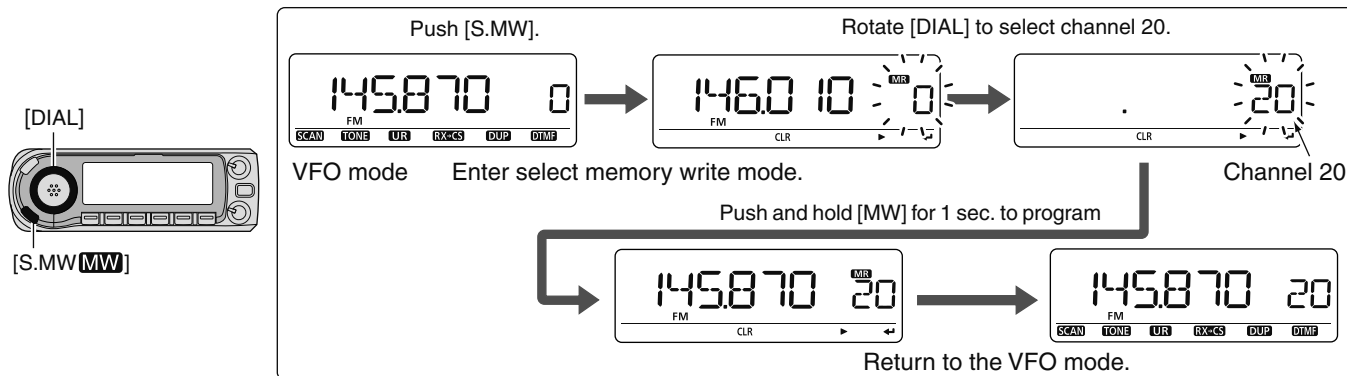

◇ Programming a memory channel via the microphone



The microphone can also be used to program memory channels.

- 1 Set the desired frequency in the VFO mode.
  - ➔ Push [VFO/LOCK] to select the VFO mode.
  - ➔ Push [ENT C(T-OFF)], then set the frequency using the keypad.
  - ➔ Set other data (e.g. frequency offset, duplex direction, tone squelch, current call signs, etc.), if desired.
- 2 Push [MR/CALL] to enter the memory mode.
- 3 Push [ENT C(T-OFF)], then set the desired memory channel using the keypad.
- 4 Push [VFO/LOCK] to select the VFO mode.
- 5 Push [FUNC] then push and hold [CLR A(MW)] for 1 sec. to program.
  - ➔ 3 beeps may sound and the VFO contents (including the subaudible tone frequency, etc.) are programmed.
  - ➔ Memory channel number increases when continuing to push [CLR A(MW)] after programming.

[EXAMPLE]: Programming 145.870 MHz into memory channel 20 (blank channel).

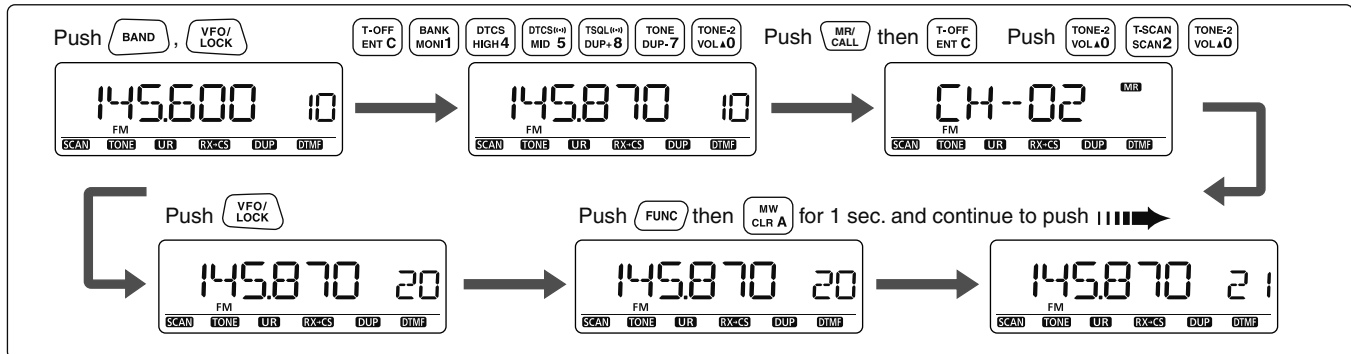

## Memory bank setting

The ID-880H has a total of 26 banks (A to Z). Regular memory channels, 0 to 999, are assigned to any desired bank for easy memory management.

- ① Push **[S.MW]** to enter the select memory write mode.
  - “**MR**” indicator and the memory channel number blink.
- ② Rotate **[DIAL]** to select the desired memory channel.
- ③ Push **[←]**(MONI) to select “**BANK**” setting.
- ④ Push **[←]**(MONI) again.
  - Bank group and channel number are displayed if the selected memory channel has already been assigned to a bank.

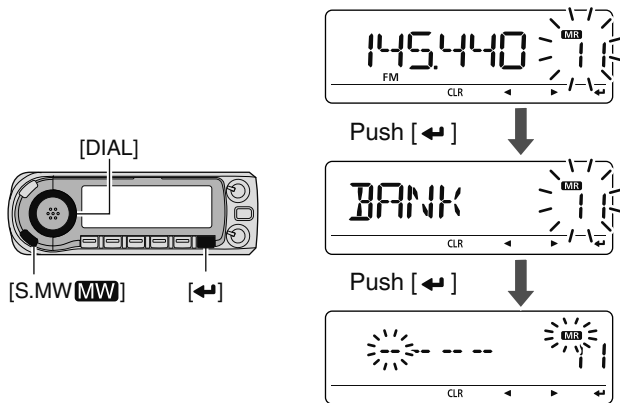

- ⑤ Rotate **[DIAL]** to select the desired bank group from “A” to “Z.”

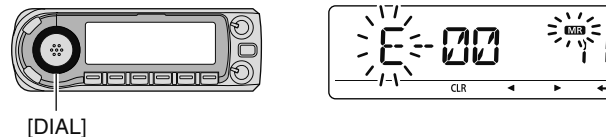

- ⑥ Push **[▶]**(LOW) to select the bank channel digit, then rotate **[DIAL]** to select the bank channel number from “00” to “99.”
  - Push **[◀]**(CS) to return to the bank group selection, if desired.

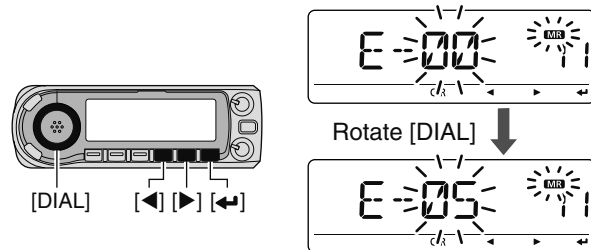

- ⑦ Push **[←]**(MONI) to set the bank initial and channel number.
- ⑧ Push and hold **[MW]**(S.MW) for 1 sec. to assign the channel to the bank.
  - Return to the previous indication before entering the select memory write mode.

## Memory bank selection

- ① Push **[M/CALL]** several times to select the memory mode.
- ② Push **[BAND]** to enter the bank selection state.
- ③ Rotate **[DIAL]** to select the desired memory bank group, then push **[BAND]** again.
  - Only programmed banks are displayed.
  - Also regular memory channel can be selected.

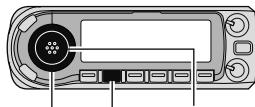

[DIAL] [M/CALL] [BAND]



Push [BAND]

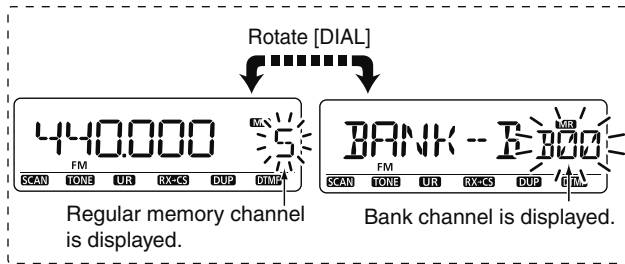

Push [BAND]



- ④ Rotate **[DIAL]** to select the bank channel.
  - Only programmed banks are displayed.

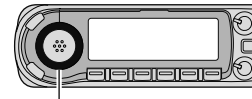

[DIAL]



- ① Push **[MR/CALL]** to select the memory mode, if desired.
- ② Push **[FUNC]** then **[MONI 1(BANK)]** to select memory bank condition.
  - Memory channel blinks
- ③ Push **[▲]/[▼]** to select the desired bank, A to Z.
  - Only programmed memory bank can be selected.
- ④ Push **[CLR A(MW)]** to set the bank.
  - Bank initial and bank channel stops blinking.
- ⑤ Push **[▲]/[▼]** to select the desired contents in the bank.
- ⑥ To return to regular memory condition, push **[FUNC]**, **[MONI 1(BANK)]** then push **[▼]** several times to select memory channel number indication.



## ■ Programming memory/bank/scan name

Each memory channel can be programmed with an alphanumeric channel name for easy recognition and can be indicated independently by channel. Memory and scan names can be a maximum of 8 characters, and bank name can be a maximum of 6 characters.

**NOTE:** Scan name indication can be turned ON or OFF in the DISP set mode (SET). (p. 132)

- ① Push **[M/CALL]** to select the memory mode.
  - To program a call channel name, push **[M/CALL]** to select the channel mode.
- ② Rotate **[DIAL]** to select the desired memory channel.
  - Select scan edge channels (0A/0B to 24A/24B) to program a scan name.
- ③ Push **[S.MW]** to enter the select memory write mode.
  - “**[MW]**” indicator and the memory channel number blink.
- ④ Push **[←](MONI)** .
- ⑤ Rotate **[DIAL]** to select “B NAME,” “M NAME” or “S NAME” when programming the bank name, the memory name or the scan name, respectively.
- ⑥ Push **[←](MONI)**.
  - A cursor blinks for the first character.
- ⑦ Rotate **[DIAL]** to select the desired character.
  - The selected character blinks.
  - Push **[▶](LOW)** to move the cursor right; push **[◀](CS)** to move the cursor left.
  - Push **[CLR](DR)** to erase the selected character, or push and hold **[CLR](DR)** for 1 sec. to erase all characters following the cursor.

- ⑧ Repeat step ⑦ until the desired channel name is programmed.
- ⑨ Push **[←](MONI)**.
- ⑩ Push and hold **[MW](S.MW)** for 1 sec. to set the name and exit channel name programming state.
  - 3 beeps sound.

**NOTE:** Only one bank name can be programmed into each bank. Therefore, the previously programmed bank name will be displayed when bank name indication is selected. Also, the programmed bank name is assigned for the other bank channels automatically.

### ◇ Available characters

A	B	C	D	E	F	G	H	I	J	K	L	M
(A)	(B)	(C)	(D)	(E)	(F)	(G)	(H)	(I)	(J)	(K)	(L)	(M)
-----												
N	O	P	Q	R	S	T	U	V	W	X	Y	Z
(N)	(O)	(P)	(Q)	(R)	(S)	(T)	(U)	(V)	(W)	(X)	(Y)	(Z)
0	1	2	3	4	5	6	7	8	9	"	#	
(0)	(1)	(2)	(3)	(4)	(5)	(6)	(7)	(8)	(9)	(!)	(")	(#)
Ⓔ	%	&	'	(	)	*	+	,	-	.	/	:
(\$)	(%)	(&)	(')	((	))	(*)	(+)	(,)	(-)	(.)	(/)	(:)
-----												
/	<	=	>	?	@	Ⓘ	\	Ⓜ	^	_		
(/)	(<)	(=)	(>)	(?)	(@)	(Ⓘ)	(\)	(Ⓜ)	(^)	(Space)		



**[EXAMPLE]:**

Programming the memory name  
"AIR" into the scan edge channel 3A.



[S.MW] [MW] [DIAL] [▶] [◀]

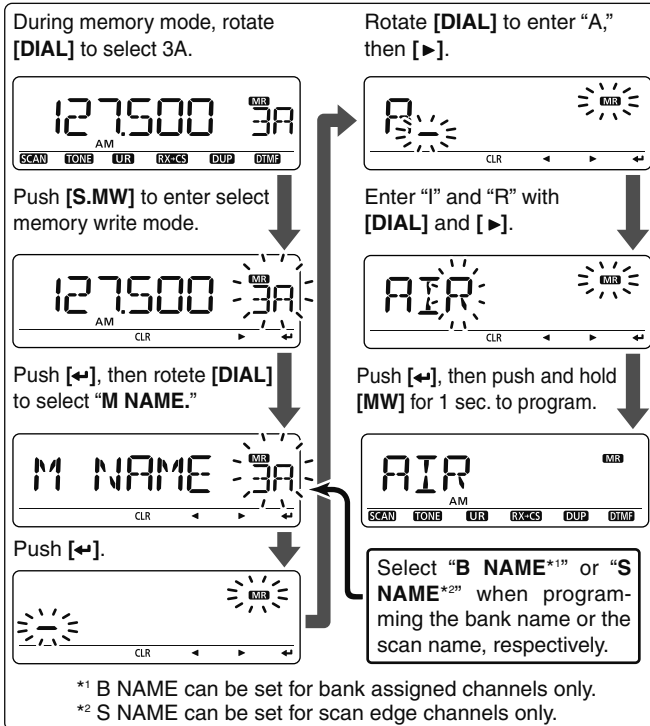

## ■ Selecting memory/bank name indication

During memory mode operation, either the programmed memory name or bank name can be displayed.

① Enter "NAME" in the DISP set mode.

MENU ⇄ SET ⇄ DISP ⇄ **NAME** (p. 131)  
(Push [MENU], (rotate [DIAL], then push [MONI].)

② Rotate [DIAL] to select the memory display type.

- OFF : Displays the frequency.
- MEMORY : Displays the memory name.
- BANK : Displays the bank name.

③ Push [MONI] to return to the DISP set mode.

④ Push [MENU] to return to the previous indication before entering the DISP set mode.

⚡ **NOTE:** The programmed scan name is displayed during the programmed scan selection.

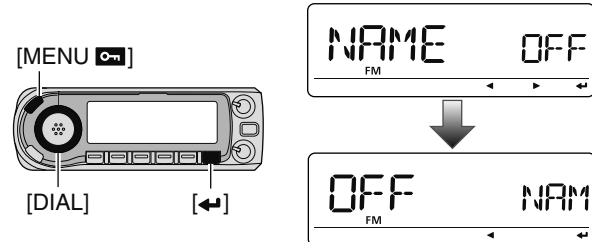

## ■ Copying memory/call contents

This function copies a memory channel's contents to the VFO (or another memory/call channel). This is useful when searching for signals around a memory channel frequency and for recalling the frequency offset, subaudible tone frequency etc.

### ◇ Memory/call → VFO

- ① Select the memory (call) channel to be copied.
  - ➔ Push **[M/CALL]** several times to select the memory mode or call channel mode, then rotate **[DIAL]** to select the desired channel.
- ② Push and hold **[MW]**(S.MW) for 1 sec. write the selected channel contents to the VFO mode.
  - Returns to the VFO mode automatically.

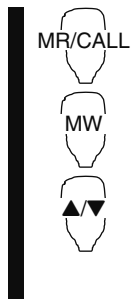

- ① Select the memory/call channel to be copied.
  - ➔ Push **[MR/CALL]** to select the memory mode, then select the desired memory channel via **[▲]**/**[▼]** or keypad.
  - ➔ Push and hold **[MR/CALL]** for 1 sec. then push **[▲]**/**[▼]** to select the call channel.
- ② Push **[FUNC]**, then push and hold **[CLR A(MW)]** for 1 sec. to copy the selected memory/call channel contents to the VFO.
  - The VFO mode is selected automatically.

**[EXAMPLE]:** Copying memory channel 11 to VFO.

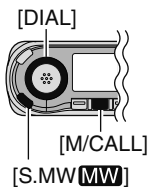

**Front panel operation:**  
 Push **[M/CALL]** to select memory mode.    Rotate **[DIAL]** for selecting memory channel.    Push and hold **[MW]** for 1 sec.

**HM-133 operation:**  
 Push **[MR/CALL]** to select memory mode.    Select memory channel.    Push **[FUNC]** then push and hold **[MW CLR A]** for 1 sec.

◇ Memory/call↔call/memory

- ① Select the memory (call) channel to be copied.
  - ➔ Push **[M/CALL]** several times to select the memory mode or call channel mode, then rotate **[DIAL]** to select the desired channel.
- ② Push **[S.MW]** to enter the select memory write mode.
  - “**MR**” indicator and the memory channel number blink.
  - Do not hold **[S.MW](MW)** for more than 1 sec., otherwise the memory contents will be copied to the VFO.
- ③ Rotate **[DIAL]** to select the target memory (call) channel.
  - Scan edge channels, 0A/0B to 24A/24B can also be selected.
- ④ Push and hold **[MW](S.MW)** for 1 sec. to write the selected channel contents to the target channel.
  - The targeted memory and copied contents are indicated.

**[EXAMPLE]:** Copying memory channel 11 contents to channel 15.

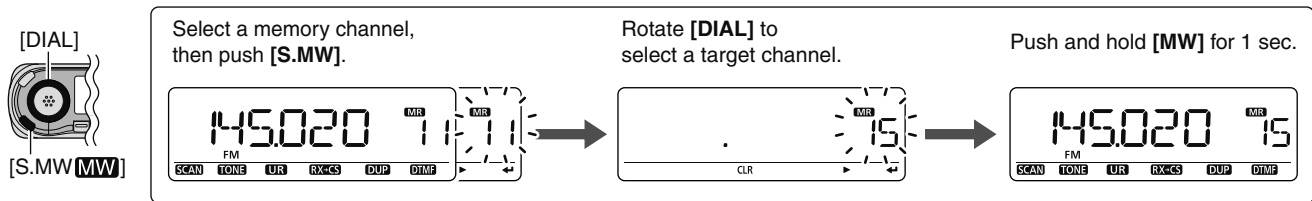

## 7 MEMORY/CALL CHANNELS

### Memory clearing

Contents of programmed memories can be cleared (erased), if desired.

- ① Push **[S.MW]** to enter the select memory write mode.
  - “**MR**” indicator and the memory channel number blink.
  - Do not hold **[S.MW]**(MW) for more than 1 sec. in the VFO mode otherwise the selected memory channel will be overwritten.
- ② Rotate **[DIAL]** to select the desired memory channel to be cleared.
- ③ Push and hold **[CLR]**(DR) for 1 sec. to clear the contents.
  - 3 beeps sound, then the frequency is cleared.
  - “**MR**” indicator and the memory channel number blink continuously.

**[EXAMPLE]:** Clearing memory channel 14.

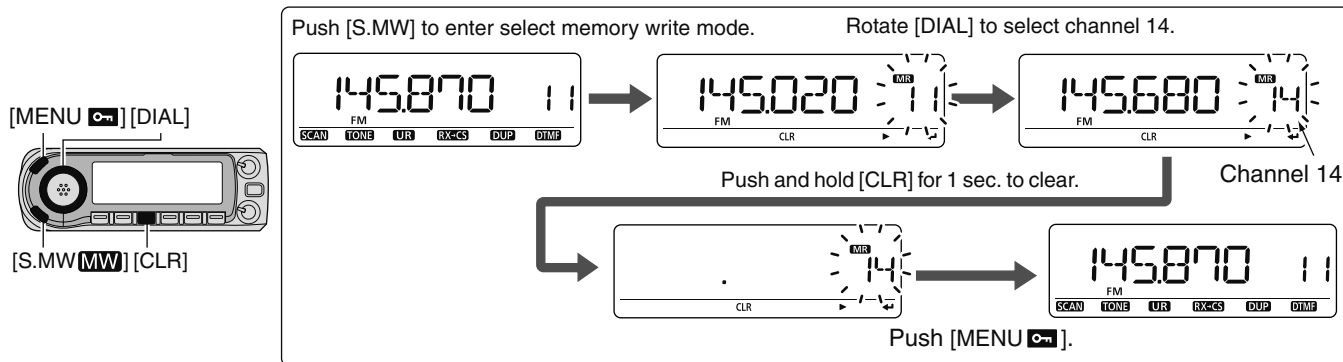

- ④ Push **[MENU]** to the previous indication before entering the select memory write mode.

**NOTE:** Be careful!— the contents of cleared memories **CANNOT** be recalled.

## Erasing/transferring bank contents

The bank contents of programmed memory channels can be cleared or reassigned to another memory bank.

**INFORMATION:** Even if the memory bank contents are cleared, the memory channel contents still remain programmed.

- 1 Select the desired bank contents to be transferred or erased from the bank. (p. 93)

- ➔ Push **[M/CALL]** several times to select the memory mode.
- ➔ Push **[BAND]**, then rotate **[DIAL]** to select the desired memory bank group, then push **[BAND]** again.
- ➔ Rotate **[DIAL]** to select the bank channel.
  - Bank initial and bank channel stops blinking.

[DIAL] [BAND]



[S.MW] [M/CALL]



- 2 Push **[S.MW]** to enter the select memory write mode.
  - Displays the original memory channel number automatically, and then “MR” indicator and the memory channel number blink.
  - Do not hold **[S.MW]**(MW) for more than 1 sec., otherwise the memory contents will be copied to the VFO.

- 3 Push **[←]**(MONI) to select “BANK” setting, then push **[←]**(MONI) again.

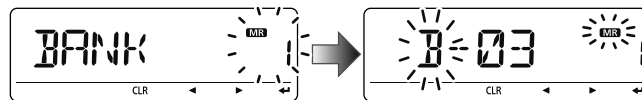

- 4 Push **[▶]**(LOW) to select the bank channels selection, or push **[◀]**(CS) to select the bank group selection to be transferred.
- 5 Rotate **[DIAL]** to select the desired bank group or channel.
  - Push **[CLR]**(DR) or select “- - - -” indication when erasing the contents from the bank.

To transfer the bank contents to channel 11 in Bank B.

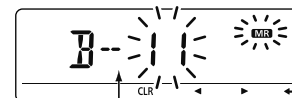

Bank channel is displayed.

To erase.

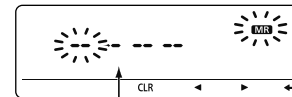

“- - - -” is displayed.

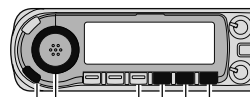

[S.MW] [DIAL] [▶] [←] [CLR]

- 6 After editing, push **[←]**(MONI) to select “BANK” setting.
- 7 Push **[MW]**(S.MW) for 1 sec. to erase/transfer the bank contents.

# 8

## SCAN OPERATION

### ■ Scan types

Scanning searches for signals automatically and makes it easier to locate new stations for contact or listening purposes.

#### **FULL SCAN** (p. 102)

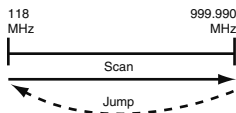

Repeatedly scans all frequencies over the entire band. Some frequency ranges are not scanned according to the frequency coverage of the transceiver's version.

#### **SELECTED BAND SCAN**

(p. 102)

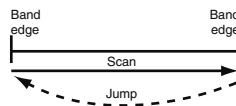

Repeatedly scans all frequencies over the entire selected band.

#### **PROGRAMMED SCAN**

(p. 102)

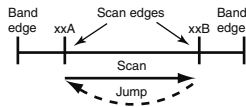

Repeatedly scans between two user-programmed frequencies. Used for checking for frequencies within a specified range such as repeater output frequencies, etc.

#### **FREQUENCY/MEMORY SKIP FUNCTION** (p. 108)

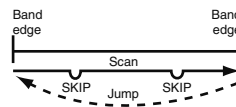

Skips unwanted frequencies or channels that inconveniently stop scanning. This setting can be turned ON or OFF for each memory channel.

#### **PROGRAMMED LINK SCAN** (pgs. 102, 125)

Repeatedly programmed scans user-programmed frequencies selected at P-LINK items in the SCAN menu screen.

**MEMORY (SKIP) SCAN**

(pgs. 105, 108)

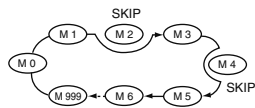

Repeatedly scans memory channels except those set as skip channel. This setting can be turned ON or OFF for each memory channel.

**BAND MEMORY (SKIP) SCAN** (p. 105)

Repeatedly scans memory channels in the same band as displayed band.

**MODE MEMORY (SKIP) SCAN** (p. 105)

Repeatedly scans memory channels in the same mode as displayed mode.

**ALL/SELECTED BANK SCAN** (p. 106)

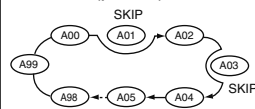

Repeatedly scans all bank channels or selected bank channels. The skip scan is also available.

**BANK-LINK SCAN** (pgs. 106, 124)

Repeatedly scans bank channels selected at BANK-LINK items in the SCAN menu screen.

## 8 SCAN OPERATION

### ■ Full/band/programmed scan

- ① Push **[VFO/MHz]** to select the VFO mode.
  - Select the desired frequency band with **[BAND]** and **[DIAL]**, if desired.
- ② Set the squelch level.
- ③ Push and hold **[SCAN]**(VFO/MHz) for 1 sec. to enter the scanning type selection.
- ④ Rotate **[DIAL]** to select the desired scanning type.
  - “ALL” for full scan; “BAND” for band scan, “P-LINK x (or program scan link name if programmed)” for programmed link scan (x= 0 to 9), “PROGxx (or scan name if programmed)” for programmed scan (xx= 0 to 24; only programmed scan edge numbers are displayed), “DUP” (appears only when duplex operation is set) for duplex scan, “TONE” (appears only when the subaudible tone, tone squelch or DTCS squelch is set) for tone scan.

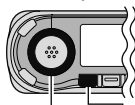

[DIAL] [SCAN]



Push and hold **[SCAN]** for 1 sec., then rotate **[DIAL]**.

Full scan



Programmed link scan



Selectable from “0” to “9.”  
Programmed scan

Band scan



Selectable from “0” to “24” if programmed.

- ⑤ Push **[SCAN]**(VFO/MHz) to start the scan.
  - Scan pauses when a signal is received.
  - Rotate **[DIAL]** to change the scanning direction. This also causes the transceiver to resume scanning.
  - Push **[SCAN]**(VFO/MHz) to stop the scan.

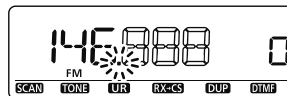

During full/band scan

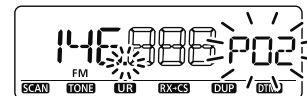

During programmed scan

/// **About the scanning steps:** The selected tuning step in each frequency band (in the VFO mode) is used during scan.

/// **Duplex scan function:** Repeatedly scans two frequencies (transmission/reception) during duplex scan operation.

Scan name can be displayed instead of “P-LINK x” for programmed link scan (x= 0 to 9), “PROGxx” for programmed scan (xx= 0 to 24) when scan name is programmed and set to ON in the DISP set mode.

MENU ⇨ SET ⇨ DISP ⇨ **SCAN N** (p. 132)  
(Push **[MENU]**), (rotate **[DIAL]**), then push **[←]**(MONI.)

Scan name is not displayed during scan.



## ■ Scan edges programming

Scan edges can be programmed in the same manner as memory channels. Scan edges are programmed into scan edges, 0A/0B to 24A/24B, in memory channels.

- ① Push **[VFO/MHz]** to select the VFO mode.
- ② Set the desired frequency:
  - ➔ Select the desired band with **[BAND]**.
  - ➔ Set the desired frequency with **[DIAL]**.
  - ➔ Program different frequencies in “\*\*A” and “\*\*B” respectively.
  - ➔ Set other data (e.g. frequency offset, duplex direction, tone squelch, etc.), if desired.
- ③ Push **[S.MW](MW)** to enter the select memory write mode.
  - “**MR**” indication and memory channel number blink.

- ④ Rotate **[DIAL]** to select the desired programmed scan edge channel from 0A to 24A.
- ⑤ Push and hold **[MW](S.MW)** for 1 sec.
  - 3 beeps sound.
  - The other scan edge channel “B,” 0B to 24B, is automatically selected when continuing to push **[MW](S.MW)** after programming.
- ⑥ To program a frequency for the other pair of scan edges, 0B to 24B, repeat steps ② and ⑤.
  - If the same frequency is programmed into a pair of scan edges, programmed scan will not function.

**[EXAMPLE]:** Programming 145.300 MHz into scan edges 4A.

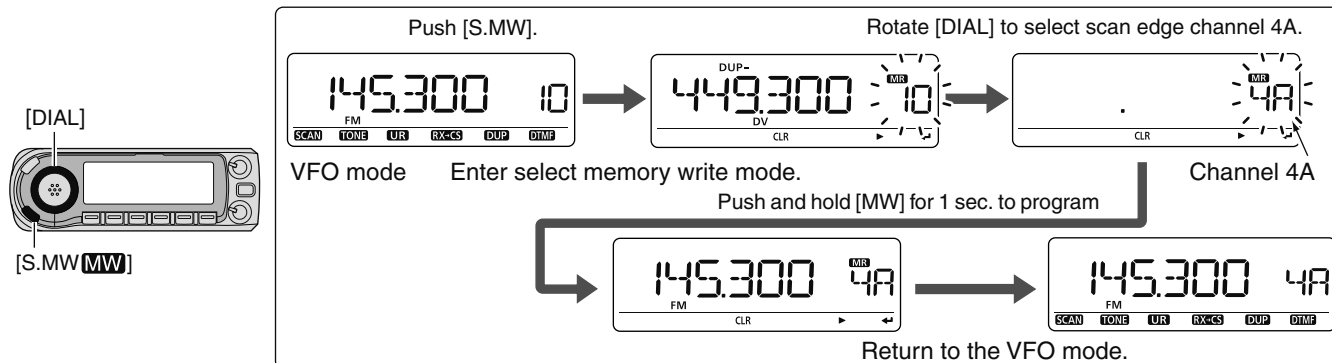

## 8 SCAN OPERATION

### ◇ Programming scan edges via the microphone



- 1 Push [MR/CALL] to select the memory mode.
- 2 Select scan edge channel, 0A to 24A using [▲]/[▼] or keypad.
  - Push [ENT C(T-OFF)] then push only 1 or 2 appropriate digit key(s), [VOL▲ 0(TONE-2)] to [SIMP 9(16-KEY-L)] then push [VOL▼ \*(TONE-1)] or [SQL▼ #(16KEY-L)] to select scan edge channels. "\*" and "#" can be used for "A" and "B" respectively.
- 3 Set the desired frequency in the VFO mode.
  - ➔ Push [VFO/LOCK] to select the VFO mode.
  - ➔ Set the frequency via the keypad or [▲]/[▼].
- 4 Push [FUNC], then push and hold [CLR A(MW)] for 1 sec. to program.
  - 3 beeps sound and the VFO is automatically selected.
  - Memory channel number advances to the next scan edge channel, 0B to 24B when continuing to push [CLR A(MW)] after programming.
- 5 To program a frequency for the other scan edge channels, repeat steps 1 to 4.

[EXAMPLE]: Programming 145.800 MHz into scan edges 4A.

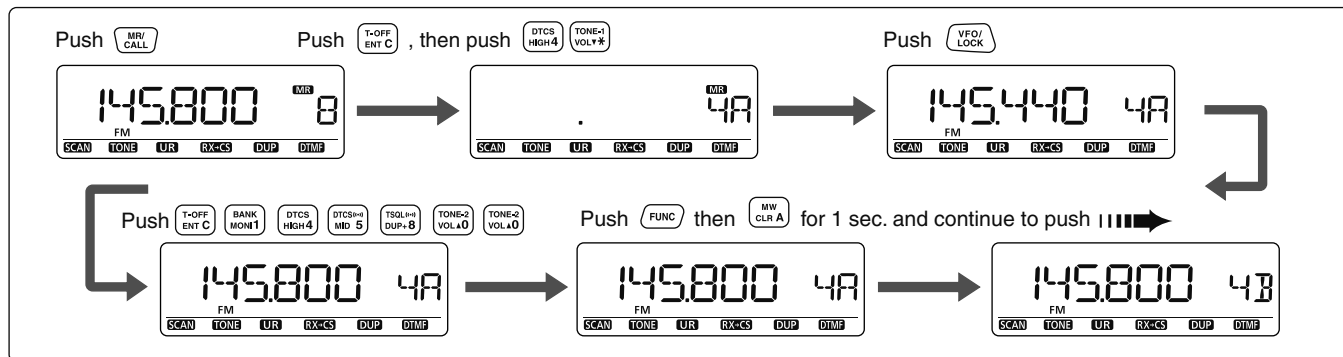

## Memory scan

**IMPORTANT:** To perform memory scan, 2 or more memory channels **MUST** be programmed, otherwise the scan will not start.

- ① Push **[M/CALL]** several times to select the memory mode.
- ② Set the squelch level.
- ③ Push and hold **[SCAN]**(VFO/MHz) for 1 sec. to enter the scanning type selection.
- ④ Rotate **[DIAL]** to select the desired scanning type.
  - “ALL” for all memory scan; “BAND” for band memory scan, “MODE” for mode scan, “DUP” (appears only when duplex operation is set) for duplex scan, “TONE” (appears only when the subaudible tone, tone squelch or DTCS squelch is set) for tone scan.

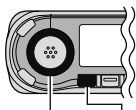

[DIAL] [SCAN]

Push and hold **[SCAN]** for 1 sec., then rotate **[DIAL]**.

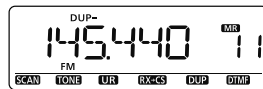

All memory scan

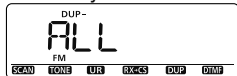

Mode scan



Selected mode is displayed.

Band memory scan



Duplex scan

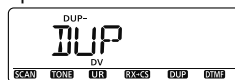

- ⑤ Push **[SCAN]**(VFO/MHz) to start the scan.
  - Scan pauses when a signal is received.
  - Rotate **[DIAL]** to change the scanning direction. This also causes the transceiver to resume scanning.
  - Push **[SCAN]**(VFO/MHz) to stop the scan.

During memory scan

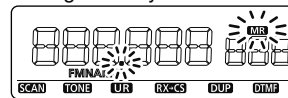

During mode scan

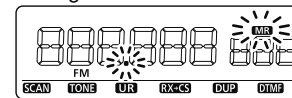

**Band memory scan function:** Repeatedly scans all memory channels programmed with any frequencies of the band programmed in the memory channel selected for scanning.

**Mode scan function:** Repeatedly scans all memory channels in which the same operating mode as the selected memory channel has been programmed.

**Duplex scan function:** Repeatedly scans two frequencies (transmission/reception) during duplex scan operation.

## 8 SCAN OPERATION

### Memory bank scan

**IMPORTANT:** To perform memory bank scan, 2 or more bank channels **MUST** be programmed, otherwise the scan will not start.

- ① Select memory bank mode.
  - ➔ Select the memory mode with **[M/CALL]**.
  - ➔ Enter the bank selection state with **[BAND]**.
  - ➔ Set the desired bank (A to Z) with **[DIAL]**, then push **[BAND]**.
- ② Set the squelch level.
- ③ Push and hold **[SCAN]**(VFO/MHz) for 1 sec. to enter the scanning type selection.

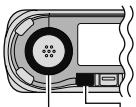

[DIAL] [SCAN]



Push and hold **[SCAN]** for 1 sec., then rotate **[DIAL]**.



<p>All bank scan</p>	<p>Bank scan</p> <p>Selectable from "A" to "Z" if programmed.</p>
<p>Bank link scan</p>	<p>Duplex scan</p>

- ④ Rotate **[DIAL]** to select the desired scanning type.
  - "ALL" for all bank scan; "B-LINK" for bank link scan or "BANK-x" for bank scan (x= A to Z; programmed bank groups are only displayed.), "DUP" (appears only when duplex operation is set) for duplex scan, "TONE" (appears only when the subaudible tone, tone squelch or DTCS squelch is set) for tone scan.
- ⑤ Push **[SCAN]**(VFO/MHz) to start the scan.
  - Scan pauses when a signal is received.
  - Rotate **[DIAL]** to change the scanning direction. This also causes the transceiver to resume scanning.
  - Push **[SCAN]**(VFO/MHz) to stop the scan.

During all bank/bank link scan

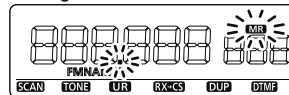

During bank scan

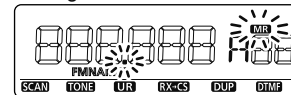

The bank-link setting can be changed in the SCAN set mode. See page 124 for details.

**Duplex scan function:** Repeatedly scans two frequencies (transmission/reception) during duplex scan operation.

Memory bank scan skips any memory channels in the selected bank that are set to "SKIP" or "PSKIP"  
Memory bank scan stops at the first channel when all channels in a bank are set to "SKIP" or "PSKIP"

## ◇ Scan start/stop via the microphone



- 1 Push [VFO/LOCK] to select the VFO mode for full/band/programmed scan; push [MR/CALL] to select the memory mode for memory scan.
  - Push [FUNC] + [MONI 1(BANK)] then push [▲]/[▼] to select a bank for memory bank scan. Push [CLR A(MW)].
- 2 Push [SCAN 2(T-SCAN)].
- 3 Push [▲]/[▼] to select the desired scanning type.

### • For full/band/programmed scan

“ALL” for full scan; “BAND” for band scan, “P-LINK x (or program scan link name if programmed)” for programmed link scan (x= 0 to 9), “PROGxx (or scan name if programmed)” for programmed scan (xx= 0 to 24; only programmed scan edge numbers are displayed), “DUP” (appears only when duplex operation is set) for duplex scan, “TONE” (appears only when the subaudible tone, tone squelch or DTCS squelch is set) for tone scan.

### • For memory scan

“ALL” for all memory scan; “BAND” for band memory scan, “MODE” for mode scan, “DUP” (appears only when duplex operation is set) for duplex scan, “TONE” (appears only when the subaudible tone, tone squelch or DTCS squelch is set) for tone scan.



### • For memory bank scan

“ALL” for all bank scan; “B-LINK” for bank link scan or “BANK-x” for bank scan (x= A to Z; programmed bank groups are only displayed.), “DUP” (appears only when duplex operation is set) for duplex scan, “TONE” (appears only when the subaudible tone, tone squelch or DTCS squelch is set) for tone scan.

- 4 Push [SCAN 2(T-SCAN)] again to start the scan.
- 5 To stop the scan push [SCAN 2(T-SCAN)] or [CLR A(MW)].
  - Push [▲]/[▼] also stops the scan.



- 1 Push [VFO/LOCK] to select the VFO mode for full scan; push [MR/CALL] to select the memory mode for memory scan.
  - Push [FUNC] + [MONI 1(BANK)] then push [▲]/[▼] to select a bank for memory bank scan. Push [CLR A(MW)].
- 2 Push and hold [▲]/[▼] to start the scan.
- 3 Push [▲]/[▼] to stop the scan.

## 8 SCAN OPERATION

### ■ Skip channel/frequency setting

Memory channels can be set to be skipped during memory skip scan. In addition, memory channels can be set to be skipped during both memory skip scan and frequency skip scan. This is useful to speed up the scan rate.

① Select a memory channel:

- ➔ Push **[M/CALL]** to select the memory mode.
- ➔ Rotate **[DIAL]** to select the desired channel to be a skip channel/frequency.



[DIAL]/[M/CALL]



② Push **[S.MW]**(MW) to enter the select memory write mode.

- “**MR**” indicator and the memory channel number blink.



③ Push **[←]**(MONI).

④ Rotate **[DIAL]** to select “SKIP,” then push **[←]**(MONI).

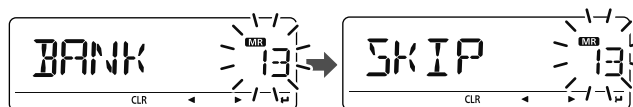

Rotate [DIAL]

Push [←]



[S.MW]/[MW] [DIAL] [←]



⑤ Rotate **[DIAL]** to select the skip condition from “SKIP,” “PSKIP” or “OFF” for the selected channel.

- **PSKIP** : The channel is skipped during memory/bank scan and the programmed frequency is skipped during VFO scan, such as programmed scan.
- **SKIP** : The channel is skipped during memory or bank scan.
- **OFF** : The channel is scanned during any scan.

⑥ Push **[←]**(MONI), then push and hold **[MW]**(S.MW) for 1 sec. to store the skip condition into the memory.

- “**SKIP**” or “**P SKIP**” appears, according to the skip selection in the step ⑤.



Skip channel setting



Program skip setting

## ■ Scan resume condition

### ◇ Scan pause timer

The scan pauses when receiving signals according to the scan pause time. It can be set from 2 to 20 sec. or unlimited.

- ① Enter “PAUSE” in the SCAN set mode.

MENU ⇨ SCAN ⇨ **PAUSE** (p. 123)  
(Push [MENU], (rotate [DIAL], then push [←](MONI).)

- ② Rotate [DIAL] to select the desired scan pausing time from 2–20 sec. (2 sec. steps) or “HOLD.”
- “2SEC”–“20SEC”: Scan pauses for 2–20 sec. while receiving a signal.
  - “HOLD” : Scan pauses on a received a signal until it disappears.

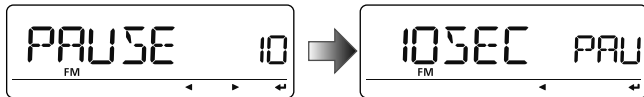

- ③ Push [←](MONI) to return to the SCAN set mode.  
④ Push [MENU] to return to frequency indication.

### ◇ Scan resume timer

The scan restarts after the signal disappears according to the resume time. It can be set from 0–5 sec. or unlimited.

- ① Enter “RESUME” in the SCAN set mode.

MENU ⇨ SCAN ⇨ **RESUME** (p. 123)  
(Push [MENU], (rotate [DIAL], then push [←](MONI).)

- ② Rotate [DIAL] to select the desired scan resume time from 0–5 sec. (1 sec. steps) and “HOLD.”
- “0SEC” : Scan restarts immediately after the signal disappears.
  - “1SEC”–“5SEC”: Scan restarts 1–5 sec. after the signal disappears.
  - “HOLD” : Scan remains paused on the received signal according to the scan pause timer even if it disappears. Rotate [DIAL] to resume manually.

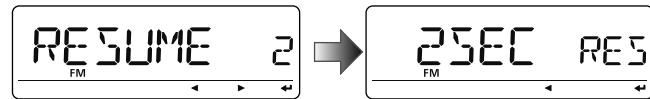

- ③ Push [←](MONI) to return to the SCAN set mode.  
④ Push [MENU] to return to frequency indication.

/// Scan resume timer must be set shorter than the scan pause timer, otherwise this timer does not activate.

## 8 SCAN OPERATION

### ■ Skip channel/frequency setting (continued)

#### ◇ Setting Pause timer via the microphone



- 1 Push [BAND] to select the desired band.
- 2 Enter "PAUSE" in the SCAN set mode.

MENU ⇄ SCAN ⇄ **PAUSE** (p. 123)  
(Push [SET B(D-OFF)] to enter the MENU screen,  
(Push [▲] or [▼], then push [SET B(D-OFF)].)

- 3 Push [▲]/[▼] to select the scan resume condition, then push [SET B(D-OFF)].
  - See step ② at previous page for scan pause timer details.
- 4 Push [CLR A(MW)] to exit set mode.

#### ◇ Setting Resume timer via the microphone



- 1 Push [BAND] to select the desired band.
- 2 Enter "RESUME" in the SCAN set mode.

MENU ⇄ SCAN ⇄ **RESUME** (p. 123)  
(Push [SET B(D-OFF)] to enter the MENU screen,  
(Push [▲] or [▼], then push [SET B(D-OFF)].)

- 3 Push [▲]/[▼] to select the scan resume condition, then push [SET B(D-OFF)].
  - See step ② at previous page for scan resume timer details.
- 4 Push [CLR A(MW)] to exit set mode.



## Priority watch types

Priority watch checks for signals on the frequency every 5 sec. while operating on a VFO frequency or scanning (except DR mode watch). The transceiver has 4 priority watch types to suit your needs.

The watch resumes according to the selected scan resume condition. See page 109 for details.

**NOTE:** If the pocket beep function is activated, the transceiver automatically selects the tone squelch function when priority watch starts.

### About priority beep function

When receiving a signal on the priority frequency, you can be alerted with beeps and a blink “(••)”. This function can be activated when setting the priority watch function ON.

#### MEMORY/CALL CHANNEL WATCH

While operating on a VFO frequency, priority watch checks for a signal on the selected channel every 5 sec.

- A memory channel with skip information can be watched.

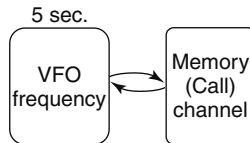

#### MEMORY SCAN WATCH

While operating on a VFO frequency, priority watch checks for signals on each memory channel in sequence.

- The memory skip function and/or memory bank scan is useful to speed up the scan.

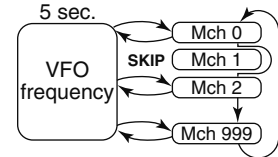

#### VFO SCAN WATCH

While scanning in the VFO mode, priority watch checks for signals on the selected channel every 5 sec.



#### DR MODE WATCH

While operating in the DR mode, priority watch checks for a signal on the VFO frequency every 5 sec.

- The access repeater scan is also available during priority watch.

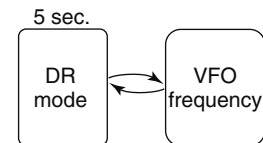

## Priority watch operation

### Memory/call channel and memory scan watch

① Select the VFO mode; then, set an operating frequency.

② Select the channel(s) to be watched.

#### For memory channel watch:

Select the desired memory channel.

#### For call channel watch:

Select the desired call channel.

#### For memory scan watch:

➤ Select the memory mode, or the desired bank group.

➤ Push and hold [SCAN](VFO/MHz) for 1 sec. to enter the scan type selection.

➤ Rotate [DIAL] to select the desired scan type, then push [SCAN](VFO/MHz) again to start memory/bank scan.

③ Enter "PRIO" in the SCAN set mode.

MENU ⇨ SCAN ⇨ **PRIO** (p. 123)

(Push [MENU]), (rotate [DIAL], then push [←](MONI).)

④ Rotate [DIAL] to select "ON."

- Select "BELL" if the priority beep function is desired.

⑤ Push [MENU] to exit the SCAN set mode and start the watch.

- "PRIO" indicator appears.

- The transceiver checks the memory/bank channel(s) or call channel every 5 sec.

- The watch resumes according to the selected scan resume condition. (p. 109)

⑥ Push [MENU] to cancel the watch.

#### During priority watch

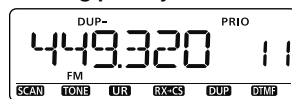

Monitors VFO frequency for 5 sec.

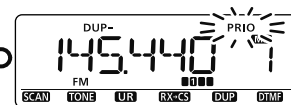

Pauses on a memory or call channel when a signal is received.

#### During priority watch with priority beep



Emits beep and blinks "((•))" indicator when a signal is received on a memory or call channel.

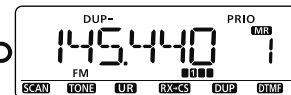

**NOTE:** When "GPS.ATX" (GPS auto transmission timer) is set to "5SEC," the priority watch functions will not work properly.

◇ VFO scan watch

① Select the channel(s) to be watched.

**For memory channel watch:**

Select the desired memory channel.

**For call channel watch:**

Select the desired call channel.

**For memory scan watch:**

- ➔ Select the memory mode, or the desired bank group.
- ➔ Push and hold [SCAN](VFO/MHz) for 1 sec. to enter the scan type selection.
- ➔ Rotate [DIAL] to select the desired scan type, then push [SCAN](VFO/MHz) again to start memory/bank scan.

② Enter “PRIO” in the SCAN set mode.

MENU ⇨ SCAN ⇨ **PRIO** (p. 123)  
 (Push [MENU], (rotate [DIAL], then push [←](MONI.)

③ Rotate [DIAL] to select “ON.”

- Select “BELL” if the priority beep function is desired.

④ Push [MENU] to exit the SCAN set mode and start the watch.

- “PRIO” indicator appears.

⑤ Push and hold [SCAN](VFO/MHz) for 1 sec. to enter scan type selection.

⑥ Rotate [DIAL] to select the desired scan type from “ALL,” “BAND” “P-LINK x (x= 0–9)” and “PROGxx (xx= 0–24),” “DUP.”

⑦ Push [SCAN](VFO/MHz) to start the VFO scan watch.

- The transceiver checks the memory/bank channel(s) or call channel every 5 sec.
- The watch resumes according to the selected scan resume condition. (p. 109)

⑧ Push [MENU] to cancel the watch.

• During priority watch

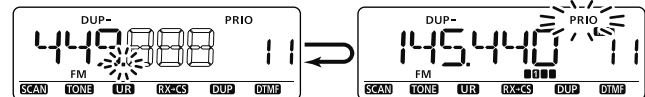

Searches VFO frequencies for 5 sec.

Pauses on a memory or call channel when a signal is received.

• During priority watch with priority beep

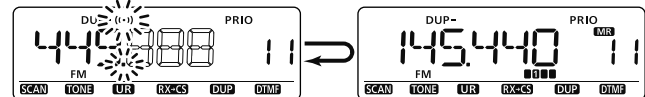

Emits beep and blinks “(•)” indicator when a signal is received on a memory or call channel.

## ◇ Memory/call channel and memory scan watch via the microphone



- 1 Select the VFO mode; then, set the desired frequency.
- 2 Set the watched channel(s).  
**For memory channel watch:**  
 Push [MR/CALL] then [▲] or [▼] to select the desired memory channel.  
**For memory scan watch:**
  - Select the memory mode, or desired bank group.
  - Push [SCAN 2(T-SCAN)] to enter the scan type selection.
  - Push [▲] or [▼] to select the desired scan type, then push [SCAN 2(T-SCAN)] to start the memory scan.**For call channel watch:**  
 Push [MR/CALL] for 1 sec. then push [▲] or [▼] to select the call channel.
- 3 Push [PRIO 3(PTT-M)] to start the watch.
  - The transceiver checks the memory or call channel every 5 sec.
  - The watch resumes according to the selected scan resume condition. (p. 109)
  - To resume the watch manually when paused, push [PRIO 3(PTT-M)].
- 4 To stop the watch, push [CLR A(MW)].

## ◇ VFO scan watch via the microphone



- 1 Select the VFO mode; then, set the desired frequency.
- 2 Set the watched channel(s).  
**For memory channel watch:**  
 Push [MR/CALL] then [▲] or [▼] to select the desired memory channel.  
**For memory scan watch:**
  - Select the memory mode, or desired bank group.
  - Push [SCAN 2(T-SCAN)] to enter the scan type selection.
  - Push [▲] or [▼] to select the desired scan type, then push [SCAN 2(T-SCAN)] to start the memory scan.**For call channel watch:**  
 Push [MR/CALL] for 1 sec. then push [▲] or [▼] to select the call channel.
- 3 Push [PRIO 3(PTT-M)] to start the watch.
  - The transceiver checks the memory or call channel every 5 sec.
  - The watch resumes according to the selected scan resume condition. (p. 109)
  - To resume the watch manually when paused, push [PRIO 3(PTT-M)].
- 4 Push [SCAN 2(T-SCAN)] to enter scan type selection.
- 5 Push [▲] or [▼] to select the desired scan type from “ALL,” “BAND” “P-LINK x (x= 0–9)” and “PROGxx (xx= 0–24),” “DUP.”

☞ Continues to the next page

◇ VFO scan watch via the microphone (Continued)

- 6 Push [SCAN 2(T-SCAN)] to start the VFO scan watch.
  - The transceiver checks the memory/bank channel(s) or call channel every 5 sec.
  - The watch resumes according to the selected scan resume condition. (p. 109)
- 7 To stop the watch, push [CLR A(MW)].

◇ DR mode/VFO watch

- 1 Select the VFO mode; then, set an operating frequency.
- 2 Push [DR] to enter the DR mode.
- 3 Select the access repeater to be watched.
  - For a specific repeater watch:**  
Select the desired access repeater.
  - For repeater scan watch:**  
Push and hold [SCAN](VFO/MHz) for 1 sec. to start the access repeater scan.
- 4 Enter "PRIO" in the SCAN set mode.
 

MENU ⇄ SCAN ⇄ PRIO (p. 123)  
 (Push [MENU], (rotate [DIAL], then push [←](MONI).)
- 5 Rotate [DIAL] to select "ON."
  - Select "BELL" if the priority beep function is desired.

- 6 Push [MENU] to exit the SCAN set mode and start the watch.
  - "PRIO" indicator appears.
  - The transceiver checks the VFO mode every 5 sec.
  - The watch resume according to the selected scan resume condition. (p. 109)
- 7 Push [VFO/MHz] to cancel the watch.

• During priority watch

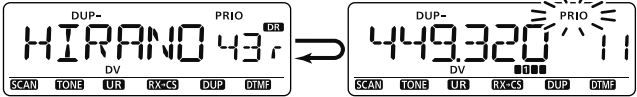

Monitors DR mode for 5 sec. Pauses on a VFO mode when a signal is received.

• During priority watch with priority beep

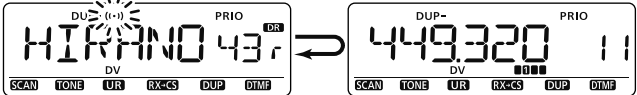

Emits beep and blinks "(•)" indicator when a signal is received on a VFO mode.

# 10 MENU SCREEN OPERATION

## ■ General

MENU screen is used for programming infrequently changed values or conditions of functions.

### ◇ Entering MENU screen and operation

[EXAMPLE]: Set "KEY B" (Key-touch beep) to OFF.

- ① Push [MENU] to enter the MENU screen.
  - One of "TS," "DUPT," "SCAN," "SET," "DV SET," "CALL-S," "RX CAL," "MESSAG," "RPT-L" or "GPS" appears.
- ② Rotate [DIAL] to select "SET," then push [↩](MONI).
  - Push [⏪](CS) to select the previous indication.

- ③ Rotate [DIAL] to select "SOUNDS," then push [↩](MONI).
  - Push [⏪](CS) to select the previous indication.
- ④ Rotate [DIAL] to select "KEY B," then push [↩](MONI).
  - Push [⏪](CS) to select the previous indication.
- ⑤ Rotate [DIAL] to select "OFF," then push [↩](MONI).\*
- ⑥ Push [MENU] to return to the indication before entering the MENU screen.

\*[↩](MONI) ↔ [BAND] or [▶](LOW)

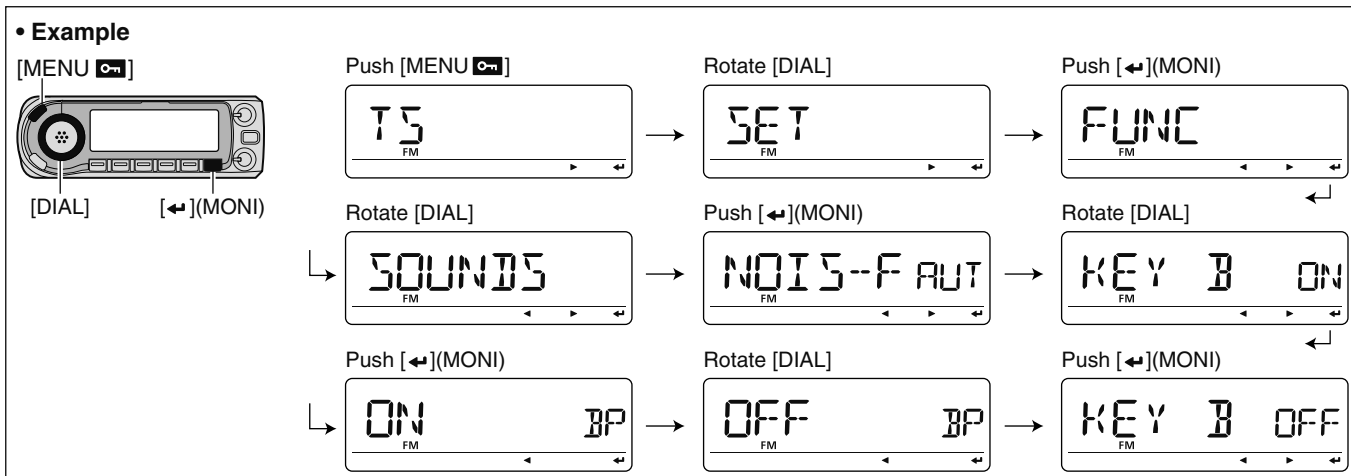

◇ Entering MENU screen via the microphone

 The microphone can also be used to set the MENU screen settings.

- 1 Push [SET B(D-OFF)] to enter the MENU screen.
  - One of “TS,” “DUP.T,” “SCAN,” “SET,” “DV SET,” “CALL-S,” “RX CAL,” “MESSAG,” “RPT-L” or “GPS” appears.
- 2 Push [▲] or [▼] to select “SET,” then push [SET B(D-OFF)].
  - Push [ENT C(T-OFF)] to select the previous indication.

- 3 Push [▲] or [▼] to select “SOUNDS,” then push [SET B(D-OFF)].
  - Push [ENT C(T-OFF)] to select the previous indication.
- 4 Push [▲] or [▼] to select “KEY B,” then push [ENT C(T-OFF)].
  - Push [ENT C(T-OFF)] to select the previous indication.
- 5 Push [▲] or [▼] to select “OFF,” then push [ENT C(T-OFF)].
- 6 Push [CLR A(MW)] to return to the indication before entering the MENU screen.

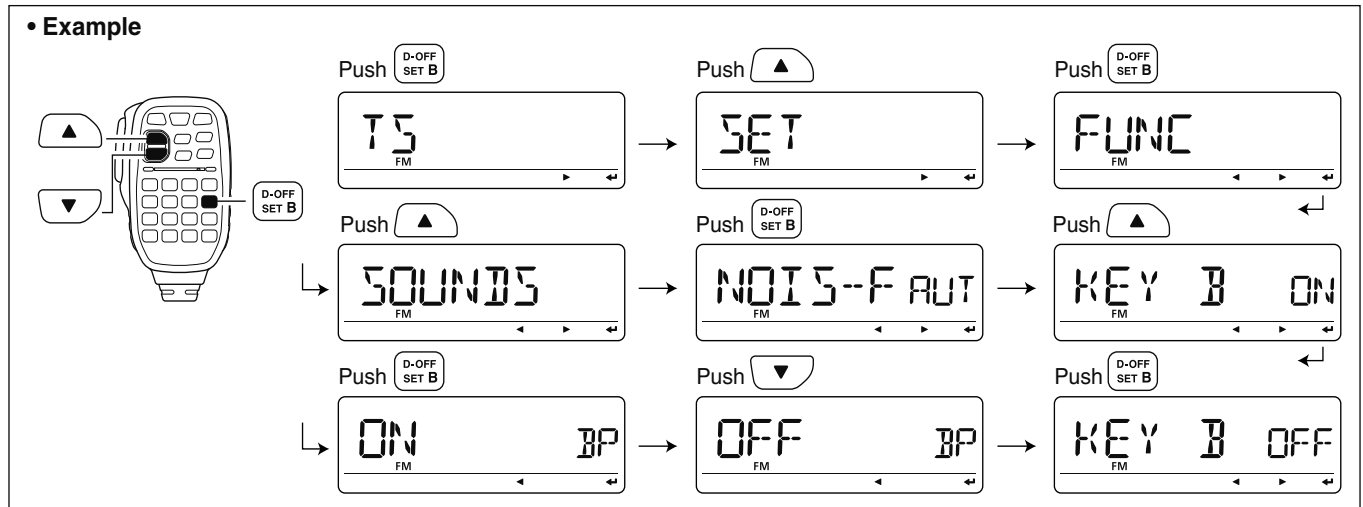

## ■ MENU screen indication and arrangement

MENU screen shows one of the following indication.

• **TS mode**

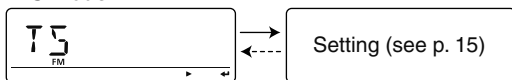

• **DUP.T mode**

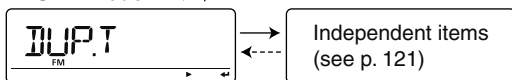

• **SCAN mode**

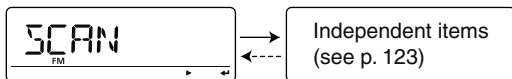

• **SET mode**

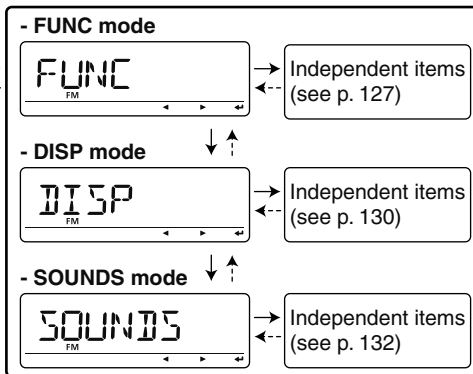
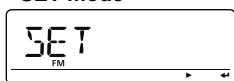

• **DV SET mode**

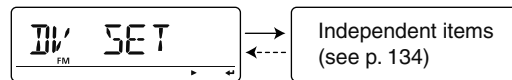

• **CALL-S mode**

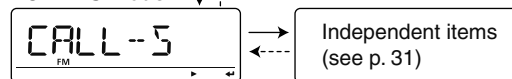

• **RX CAL mode**

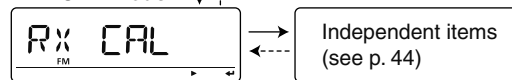

• **MESSAG mode**

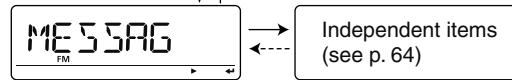

• **RPT-L mode**

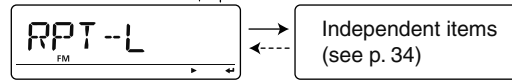

• **GPS mode**

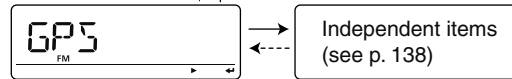



## ■ Items list

### ◇ TS mode

See page 15 for details.

### ◇ DUP.T mode

Item indication	Ref.	Item indication	Ref.
OFFSET	p. 121	DTC5-P	p. 122
R TONE	p. 121	D CODE	p. 122
C TONE	p. 121	DTMF-S	p. 122
CODE	p. 122		

### ◇ SCAN mode

Item indication	Ref.	Item indication	Ref.
PRIO	p. 123	WX-ALT	p. 124
PAUSE	p. 123	D-LINK	p. 124
RESUME	p. 123	P-LINK	p. 125
P-SKIP	p. 123		

### ◇ SET mode

#### - FUNC mode

Item indication	Ref.	Item indication	Ref.
SQL-DL	p. 127	FAN	p. 129
AT-ATT	p. 127	ACTIVE	p. 129
MIC-S	p. 127	MIC-UP	p. 129
ALC	p. 127	MIC-DN	p. 129
PTT LK	p. 127	PACKET	p. 129
LK OUT	p. 128	SPEED	p. 130
TOT	p. 128	AP OFF	p. 130
AUTORP	p. 128		

#### - DISP mode

Item indication	Ref.	Item indication	Ref.
DIMMER	p. 130	NAME	p. 131
AT-DIM	p. 130	SCAN N	p. 132
COLOR	p. 131	OPNMSG	p. 132
CONT	p. 131		

#### - SOUNDS mode

Item indication	Ref.	Item indication	Ref.
NOIS-F	p. 132	STOP B	p. 133
AF-FIL	p. 132	STBY B	p. 133
BEEPLV	p. 133	EDGE B	p. 133
KEY B	p. 133		

### ◇ DV SET mode

Item indication	Ref.	Item indication	Ref.
REPLY	p. 134	GW SET	p. 136
DATATX	p. 134	RX CS	p. 136
D MONI	p. 134	TX CS	p. 136
D RPT	p. 134	RX MSG	p. 136
CALL W	p. 135	SCROLL	p. 136
RPT W	p. 135	BK	p. 137
DV DET	p. 135	EMR	p. 137
EDIT R	p. 135		

# 10 MENU SCREEN OPERATION

## ◇ CALL-S mode

Item indication	Ref.	Item indication	Ref.
UR	p. 32	RPT2	p. 33
RPT 1	p. 33	MY	p. 31

## ◇ RX CAL mode

See p. 49 for details.

## ◇ MESSAG mode

Item indication	Ref.	Item indication	Ref.
TX MSG	p. 64	TX GPS	p. 75
RX MSG	p. 66	RX GPS	p. 76

## ◇ RPT-L mode

Item indication	Ref.	Item indication	Ref.
ADD-L	p. 35	EDIT-L	p. 40

## ◇ GPS mode

Item indication	Ref.	Item indication	Ref.
GPSSET	p. 138	ALM 1	p. 84
GPSPOS	p. 76	ALM2	p. 85
D/F	p. 78	GPS-TX	p. 138
GPSMEM	p. 80	GPSATX	p. 141
ALM-CH	p. 81		

## • GPS.SET mode

Item indication	Ref.	Item indication	Ref.
P FORM	p. 138	UTC OFF	p. 138
UNITS	p. 138	INDIC	p. 138

## • Sentence formatter setting

Item indication	Ref.	Item indication	Ref.
RMC	p. 139	GSA	p. 139
GGA	p. 139	VTG	p. 139
GLL	p. 139	GSV	p. 139

## • GPS-A mode

Item indication	Ref.	Item indication	Ref.
UNPROT	p. 139	SYMBOL	p. 140
DT EXT	p. 140	COMMENT	p. 141
TIME	p. 140		

## ■ DUP.T mode items

### ◇ Frequency offset

OFF SET

Sets the frequency offset for duplex (repeater) operation within a 0 to 159.995 MHz range.

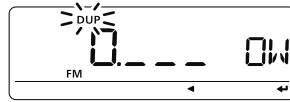

During 1 MHz step setting

➔ Push [VFO/MHz] each time to selecting the 10 MHz, 1 MHz step and the setting with the tuning step, selected in the VFO mode, in sequence.

- The default value may differ according to the selected frequency band (before accessing DUP.T mode) and transceiver version.

▨ The selected tuning step in the VFO mode is used when setting the frequency offset.

### ◇ Repeater tone frequency

R TONE

Selects subaudible tone frequency for accessing a repeater, etc. 50 tone frequencies (67.0–254.1 Hz) are available.

(default: 88.5)



### ◇ TSQL frequency

C TONE

Selects tone frequency for tone squelch or pocket beep operation from one of 50 available frequencies (67.0–254.1 Hz).

(default: 88.5)

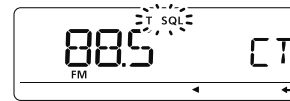

#### • Available tone frequencies

67.0	79.7	94.8	110.9	131.8	156.7	171.3	186.2	203.5	229.1
69.3	82.5	97.4	114.8	136.5	159.8	173.8	189.9	206.5	233.6
71.9	85.4	100.0	118.8	141.3	162.2	177.3	192.8	210.7	241.8
74.4	88.5	103.5	123.0	146.2	165.5	179.9	196.6	218.1	250.3
77.0	91.5	107.2	127.3	151.4	167.9	183.5	199.5	225.7	254.1

▨ The transceiver has 50 tone frequencies and consequently their spacing is narrow compared with units having 38 tones. Therefore, some tone frequencies may receive interference from adjacent tone frequencies.

# 10 MENU SCREEN OPERATION

## ◇ DTCS code

CODE

Selects DTCS (both encoder/decoder) code for DTCS squelch operation. Total of 104 codes (023–754) are available.

(default: 023)

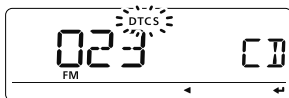

### • Available DTCS codes

023	054	125	165	245	274	356	445	506	627	732
025	065	131	172	246	306	364	446	516	631	734
026	071	132	174	251	311	365	452	523	632	743
031	072	134	205	252	315	371	454	526	654	754
032	073	143	212	255	325	411	455	532	662	
036	074	145	223	261	331	412	462	546	664	
043	114	152	225	263	332	413	464	565	703	
047	115	155	226	265	343	423	465	606	712	
051	116	156	243	266	346	431	466	612	723	
053	122	162	244	271	351	432	503	624	731	

## ◇ DTCS polarity

DTCS-P

Sets DTCS polarity from “BOTH N” (TX/RX: normal), “TN-RR” (TX: normal, RX: reverse), “TR-RN” (TX: reverse, RX: normal) and “BOTH R” (TX/RX: reverse). (default: BOTH N)

This item allows you to set the transmit and receive DTCS code polarities independently.



## ◇ Digital code

D CODE

Sets the desired digital code for digital code squelch operation. Total of 100 codes (00–99) are available. (default: 00)

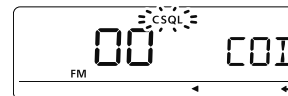

## ◇ DTMF speed

DTMF-S

Select the desired DTMF transmission speed from 100 msec, 200 msec, 300 msec, 500 msec.

- 100 : 100 msec. interval; 5.0 characters per second (default)
- 200 : 200 msec. interval; 2.5 characters per second
- 300 : 300 msec. interval; 1.6 characters per second
- 500 : 500 msec. interval; 1.0 character per second

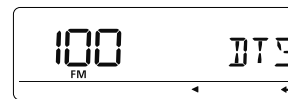

## ■ SCAN mode items

### ◇ Priority watch

PRI

Activates priority watch or priority watch with alert (Bell).

- OFF : The priority watch is turned OFF. (default)
- ON : The transceiver checks the memory channel frequency every 5 sec.
- BELL : The transceiver checks the memory channel frequency every 5 sec. You can be alerted with beeps and blinking “(•)”.

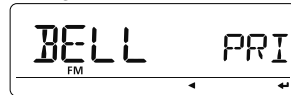
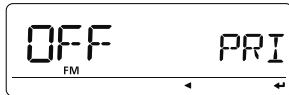

### ◇ Scan pause timer

PAUSE

Selects the scan pause time. When receiving signals, the scan pauses according to the scan pause time.

- 2–20SEC: Scan pauses for 2–20 sec. on a received signal in 2 sec. steps. (default: 10 sec.)
- HOLD : Scan pauses on a received signal until it disappears.

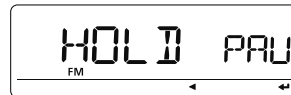

### ◇ Scan resume timer

RESUME

Selects the scan resume time from a pause after the received signal disappears.

- 0SEC : Scan resumes when a received signal disappears.
- 1–5SEC : Scan pauses 1–5 sec. after a received signal disappears. (default: 2 sec.)
- HOLD : Scan remains paused on the received signal according to the scan pause timer even if it disappears. Rotate [DIAL] to resume manually.

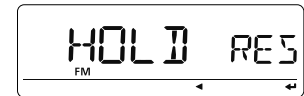
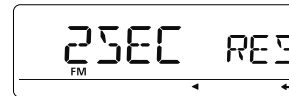

Scan resume timer must be set shorter than scan pause timer (previous item), otherwise this timer does not function.

### ◇ Program skip scan

P-SKIP

Sets programmed skip scan function ON (default) and OFF for VFO scan (full scan, programmed scan, etc.) operation.

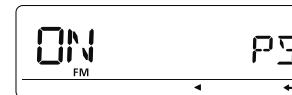

## 10 MENU SCREEN OPERATION

### ◇ Weather alert

WX-ALT

USA/CHN/EXP versions only

Turns weather alert function ON or OFF. (p. 162)  
(default: OFF)

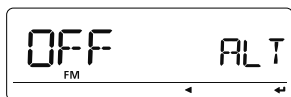

### ◇ Memory bank link function

B-LINK

Sets the memory bank link function ON or OFF (default). The link function provides continuous bank scan, scanning all contents in the selected banks during bank scan.

#### • Bank link setting

- ① Rotate [DIAL] to select the bank that you want to change.

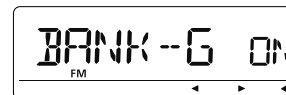

- ② Push [←](MONI) to enter bank setting.
- ③ Rotate [DIAL] to select the setting.

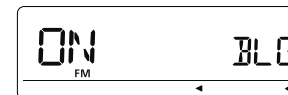
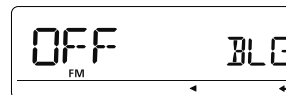

- ④ Push [←](MONI) to set and return to the BANK selection screen.
- ⑤ Rotate [DIAL] to select next bank and repeat steps ② to ④, or push [MENU] to exit the MENU screen operation.

◇ Program scan link function P-LINK

Sets the program scan link function. The link function provides continuous program scan in the selected program scan number during program scan.

Default setting for P-LINK P0 to P-LINK P9: PROG 0 to PROG 24 are linked.

• Confirming program scan link

- ① Rotate [DIAL] to select the program scan link number that you want to confirm.

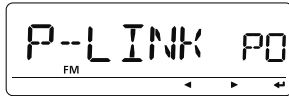

- ② Push [←](MONI) to enter program scan link setting.
- ③ Rotate [DIAL] to select "LINK."

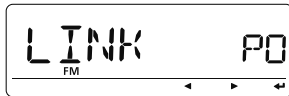

- ④ Push [←](MONI), then rotate [DIAL] to confirm the linked program scan.
- ⑤ Push [←](MONI) to exit.

• Program scan link name programming

- ① Rotate [DIAL] to select the program scan link number for which you want to program a name.



- ② Push [←](MONI) to enter program scan link setting.
- ③ Rotate [DIAL] to select "NAME."
- ④ Push [←](MONI) to enter the name programming state.

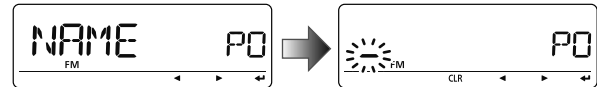

- ⑤ Rotate [DIAL] to select the desired character, number, symbol or space; push [▶](LOW) or [◀](CS) to move the cursor right or left, respectively.
- ⑥ Push [←](MONI) to program the repeater name and exit the state.
- ⑦ Push [MENU] to exit the MENU screen operation.

## 10 MENU SCREEN OPERATION

### • Program scan link setting (ADD)

- ① Rotate [DIAL] to select the program scan link number that you want to add.



- ② Push [←](MONI) to enter program scan link setting.
- ③ Rotate [DIAL] to select "ADD."



- ④ Push [←](MONI) then rotate [DIAL] to select the desired programmed scan number to be linked.



- Only programmed scan numbers that have not linked in the selected program link number are displayed.
  - Push [←](CS) to cancel the selection.
- ⑤ Push [←](MONI) to add the selected programmed scan.
    - Return to the previous indication as step ③.
  - ⑥ Repeat steps ③ to ⑤ to continue the program scan link setting or push [MENU] to exit the MENU screen operation.

### • Program scan link setting (CLEAR)

- ① Rotate [DIAL] to select the program scan link number that you want to delete.

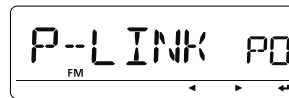

- ② Push [←](MONI) to enter program scan link setting.
- ③ Rotate [DIAL] to select "CLEAR."

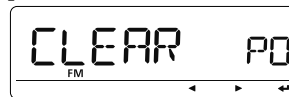

- ④ Push [←](MONI) then rotate [DIAL] to select the desired programmed scan number to be deleted from the link.



- Only programmed scan numbers that have linked in the selected program link number are displayed.
  - Push [←](CS) to cancel the selection.
- ⑤ Push [←](MONI) to delete the setting.
    - Return to the previous indication as step ③.
  - ⑥ Repeat steps ③ to ⑤ to continue the program scan link setting or push [MENU] to exit the MENU screen operation.



## ■ SET mode — FUNC items

### ◇ Squelch delay timer SQL -- DL

Selects squelch delay from short and long to prevent repeated opening and closing of the squelch during reception of the same signal.

- SHORT : Short squelch delay. (default)
- LONG : Long squelch delay

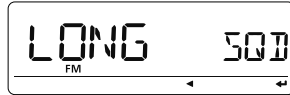
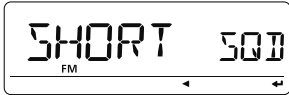

### ◇ Attenuator AT--ATT

Turns the attenuator (squelch attenuator) function ON or OFF.

- ON : The attenuator (squelch attenuator) activates when [SQL] control is set between 13 o'clock and fully clockwise position. (default)
- OFF : The attenuator (squelch attenuator) does not function.

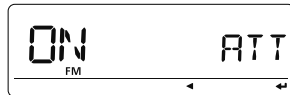
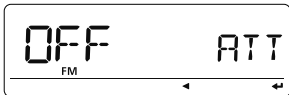

### ◇ Mic sens level MIC--S

Selects the microphone sensitivity from HIGH and LOW to suit your preference.

(default : USA version; LOW, Other versions; HIGH)

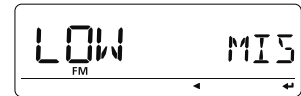
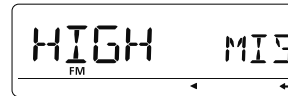

### ◇ ALC ALC

Sets the ALC (Automatic Level Control) function ON or OFF (default).

The ALC function reduces the microphone gain automatically when the transmission audio is distorted. This function is available in the FM/FM-N mode only.

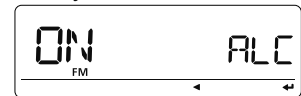
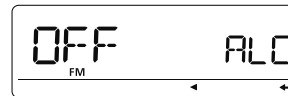

### ◇ PTT lock PTT LK

Turns the PTT lock function ON or OFF.

Transmission with [PTT] is inhibited when ON is selected to prevent accidental transmission, etc. (default: OFF)

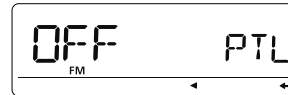

## 10 MENU SCREEN OPERATION

### ◇ Busy lockout

LK OUT

Turns the busy lockout function ON or OFF.

This function inhibits transmission while receiving a signal or when the squelch is open. (default: OFF)

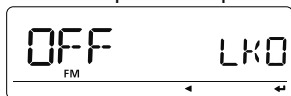

### ◇ Time-out timer

TOT

To prevent accidental prolonged transmission, etc., the transceiver has a time-out timer. This function cuts transmission OFF after 1, 3, 5, 10, 15 or 30 min. of continuous transmission. This timer can be cancelled.

- OFF : The time-out timer is turned OFF. (default)
- 1 to 30 MIN : The transmission is cut OFF after the set period elapses.

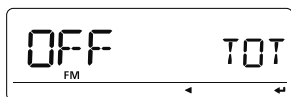

### ◇ Auto repeater

AUTORP

#### USA/CHN/EXP/KOR versions only

The auto repeater function automatically turns ON or OFF the duplex operation and tone encoder. The offset and repeater tone settings are not changed by the auto repeater function. Reset these frequencies, if necessary.

#### USA/CHN/EXP versions:

- OFF : The auto repeater function is turned OFF.
- RPT1 : Activates for duplex only. (default)
- RPT2 : Activates for duplex and tone.

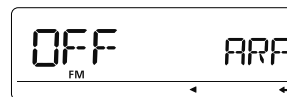

#### KOR version:

- OFF : Deactivates the function.
- ON : Activates duplex and tone. (default)

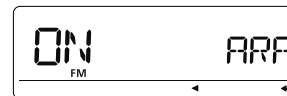
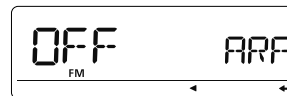

◇ Fan control

FAN

Selects the cooling fan control condition from AUTO, FAST, MID and SLOW.

- SLOW : The fan continuously rotates at low speed.
- MID : The fan continuously rotates at medium speed.
- FAST : The fan continuously rotates at fast speed.
- AUTO : The fan rotates during transmit and for 30 sec. after transmission, or when the internal temperature of the transceiver exceeds the preset value until the temperature drops. (default)

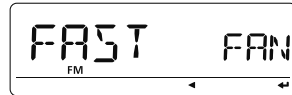
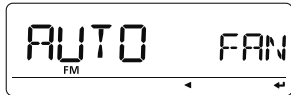

◇ Active band

ACTIVE

Allows continuous frequency selection of the operating frequency across all bands.

- SINGLE : A single operating frequency can be selected within the current band. Push [BAND] for band selection in this case.
- ALL : The operating frequency can be selected continuously. (default)

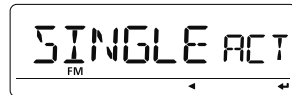

◇ Mic UP/DN

MIC --UP / MIC --DN

Sets the assigning function to the [UP]/[DN] keys on the optional M-103/HM-154.

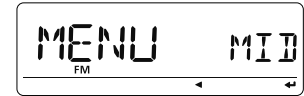
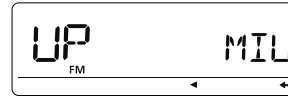

Assignable functions:

UP* (default)	DOWN† (default)
MENU (as [MENU  <td>V/MHZ (as [VFO/MHz])</td>	V/MHZ (as [VFO/MHz])
BAND (as [BAND MODE])	SMW (as [S.MW MW])
M/CALL (as [M/CALL])	DR (as [DR])
CS (as [CS])	LOW (as [LOW])
MONI (as [MONI])	

\*Available for "MIC-UP" only; †Available for "MIC-DN" only

◇ Packet speed

PACKET

Selects the data transmission speed for packet operation from 1200 bps (default) and 9600 bps.



## 10 MENU SCREEN OPERATION

### ◇ Data speed

SPEED

Selects the data speed of [DATA] jack between 4800 bps and 9600 bps (default) for low-speed data communication in the DV mode or GPS receiving.



/// This setting does not change the cloning speed.

### ◇ Auto power OFF

AP OFF

The transceiver can automatically turn itself OFF after a specified time period. Activating any control restarts the time-out period. The transceiver beeps before it turns OFF.

30 min., 60 min, 90 min, 120 min and OFF (default) can be specified. The specified time period is retained even when the transceiver is turned OFF by the auto power OFF function. To cancel the function, select "OFF" in this item.

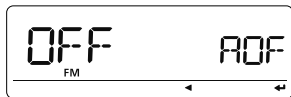

## ■ SET mode — DISP items

### ◇ Display dimmer

DIMMER

Sets backlighting brightness.

The levels 1 (dark) to 4 (bright: default) are available.

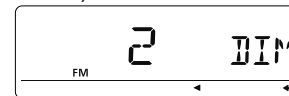
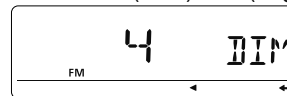

### ◇ Auto dimmer

AT-DIM

Sets backlighting brightness when no operation is performed for approx. 5 sec.

- OFF : The backlight brightness will not be changed. (default)
- AT-OFF : The backlight will be turned OFF when no operation is performed for approx. 5 sec.
- AT-D1 to D3 : Brightness level 1 to 3 is selected when no operation is performed for approx. 5 sec.

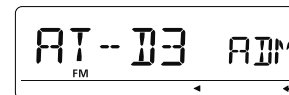
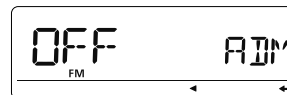

◇ Display color

COLOR

The display color can be set to amber, yellow or green (default).

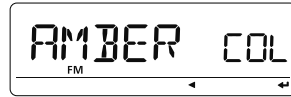
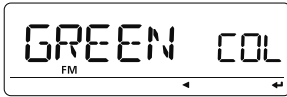

◇ LCD contrast

CONT

The contrast of the LCD can be selected from 9 levels.

- 1 (Low contrast) to 9 (High contrast) (default: 4)

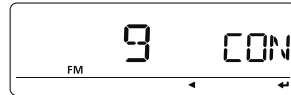
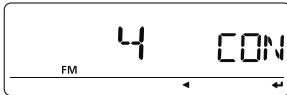

◇ Name indication type

NAME

Selects name indication type from MEMORY, BANK and OFF during memory mode operation.

- OFF : The programmed frequency is displayed.
- MEMORY : The programmed memory name is displayed. However, the programmed frequency is displayed if no memory name is programmed. (default)
- BANK : The bank name, that the selected memory channel is assigned to, is displayed. However, the programmed frequency is displayed if no bank name is programmed.

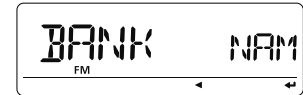
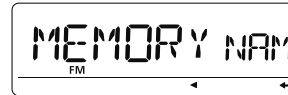

## 10 MENU SCREEN OPERATION

### ◇ Scan name

SCAN N

The programmed scan, programmed link scan or bank name is displayed during the scan type selection.

- OFF : The programmed scan number, programmed link scan number or bank initial is displayed during selection.
- ON : The programmed scan, programmed link scan or bank name is displayed. However, the programmed scan number, programmed link scan number or the default bank initial is displayed if no name is programmed. (default)

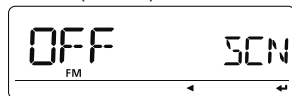

### ◇ Opening message

OPNMSG

The opening message indication that is displayed at power ON is selectable from "ICOM" logo, my call sign or skipped.

- OFF : Opening message indication is skipped.
- LOGO : "ICOM" is displayed at power ON. (default)
- CALL : The set my call sign is displayed at power ON.

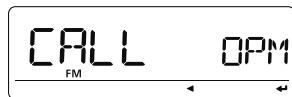

## ■ Set mode — SOUNDS items

### ◇ Noise filter

NOIS-F

- **Appears only when the FM/N or AM/N mode is selected.**

The noise filter selects audio signal filter width to reduce high-pitch noise in analog mode (FM/N, AM/N) operation— clear voice audio reception is provided. Selects the noise filter from AUTO, F1–F3.

- AUTO : Selects the suitable audio filter width according to the received signal strength. When a weak signal is received, selects a narrow audio filter width to reduce noise audio. (default)
- F1 : The widest audio filter width.
- F2 : Middle audio filter width.
- F3 : The narrowest audio filter width.

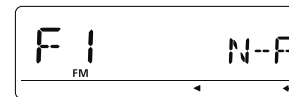
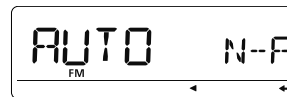

### ◇ Audio filter

AF-FIL

- **Appears only when AM/N mode is selected.**

The AF filter suppresses high-pitch tone during AM mode operation.

- OFF : The AF filter is deactivate. (default)
- ON : The AF filter is activate.

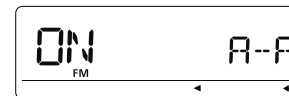
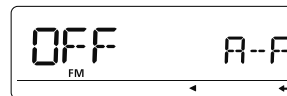

◇ Beep output level

BEEPLY

Adjusts the key-touch beep tone level to the desired level within 9 levels. (default: 7)

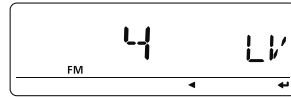
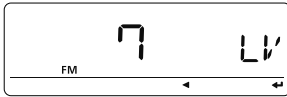

/// The key-touch beep (following item) must be set to ON to have a beep tone.

◇ Key-touch beep

KEY B

Turns the key-touch beep ON or OFF. (default: ON)

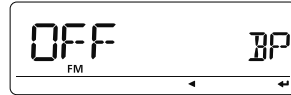
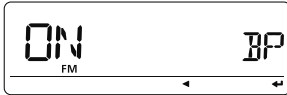

◇ Scan stop beep

STOP B

Turns the scan stop beep function ON or OFF. (default: OFF)

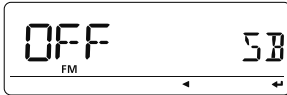

◇ Standby beep

STBY B

Turns the beep emission capability ON or OFF when the communicating station finishes transmitting or the receive signal disappears during DV mode operation. (default: ON)

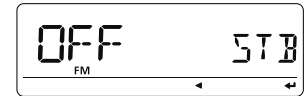

◇ Band edge beep

EDGE B

Turns the beep emission capability ON or OFF when the frequency is changed over the band edge. (default: OFF)

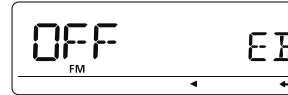

## 10 MENU SCREEN OPERATION

### ■ DV SET mode items

#### ◇ Auto reply

REPLY

Use this function to reply a station calling when you are away from the transceiver.

After a manual transmission (pushing [PTT]), the Auto Reply setting returns to OFF automatically.

- OFF : No reply is performed even if a call is received. (default)
- ON : Sets the caller's call sign and replies to the call with the programmed own call sign.

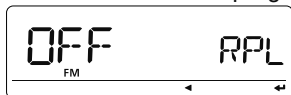

#### ◇ DV data TX

DATA TX

During low-speed data operation, auto data transmission function is available. This function activates to transmit automatically when the PC software sends data to the ID-880H via the [DATA] jack.

- PTT : Data from [DATA] transmits when [PTT] is pushed. (default)
- AUTO : Data from [DATA] transmits automatically.



#### ◇ Digital monitor

MONI

Selects the desired monitoring mode during DV mode operation between "Auto," "Digital" and "Analog."

- AUTO : The transceiver sets monitoring mode to the FM and DV according to the received signal. (default)
- DIGI : Monitors in the DV mode.
- ANALOG : Monitors in the FM mode.

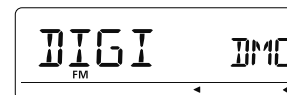

#### ◇ Digital repeater setting

RPT

When accessing a D-STAR repeater that has a call sign is different than the transceiver's current call sign, the repeater call sign can be stored into "RPT1" automatically by reading the repeater's downlink signal. The previously stored repeater's call sign can be recalled when selecting the repeater call sign.

(default: ON)

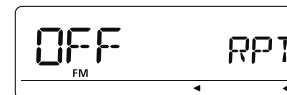
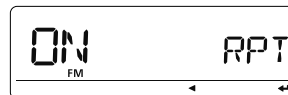



◇ RX call sign auto write

CALL W

When your own individual station call is received, the calling station call sign can be automatically set in “UR” of the current call sign. (default: OFF)

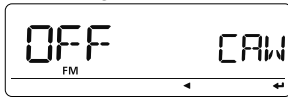

◇ Repeater call sign auto write

RPT W

When your own individual station call is received via the D-STAR repeater, the repeater call sign can be set into “RPT1” and/or “RPT2” automatically by reading the repeater’s down-link signal. (default: OFF)

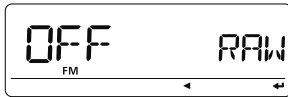

/// The transceiver sets the received repeater call sign for operation, over-writing the previously set repeater call sign.

◇ DV auto detect

DV DET

When a signal other than the DV mode is received during DV mode operation, the transceiver can automatically select the FM mode.

- OFF : Operating mode is fixed in DV. (default)
- ON : The transceiver automatically selects the FM mode for temporary operation.

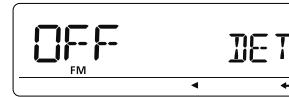

/// The received audio may be distorted with the auto detection “ON” setting for FM demodulation.

◇ Call sign edit record

EDIT R

Selects call sign programming when the call sign is edited.

- OFF : The edited or corrected call sign overwrites the pre-programmed channel. A different channel cannot be selected.
- SEL : The edited or corrected call sign is programmed into the selected call sign memory.
- AUTO : The edited or corrected call sign is programmed into a blank channel automatically. (default)

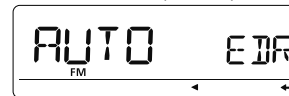

## 10 MENU SCREEN OPERATION

### ◇ Auto gateway setting

GW SET

Turn the gateway auto set function ON or OFF for calling a specific station in the DR mode. This function enables the transceiver to set the pre-programmed gateway repeater as the linked repeater "RPT2" automatically.

- OFF : After selecting a specific station, the transceiver sets the same RPT2 as previous time. (default)
- AUTO : After selecting a specific station, the transceiver sets the pre-programmed gateway repeater as RPT2 automatically.

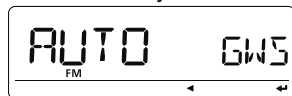
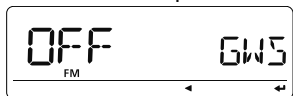

### ◇ RX call sign display

RX CS

When a call is received, the calling station call sign can be displayed automatically. (default: AUTO)

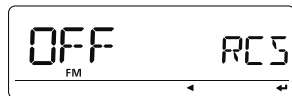

### ◇ TX call sign display

TX CS

Selects call sign display function from YOUR, MY and OFF. When this setting is set to YOUR or MY, the transceiver automatically displayed the set station or your own call sign during DV mode transmission. (default: YOUR)

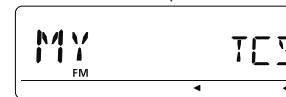
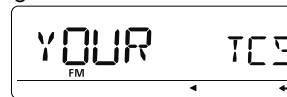

### ◇ RX message display

RX MSG

Sets auto received message display function AUTO or OFF. When this setting is set to AUTO, the transceiver automatically displays and scrolls the received message. (default: AUTO)

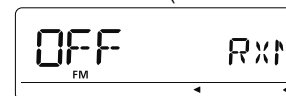

### ◇ Scroll speed

SCROLL

Set the displayed message, call sign, etc. scrolling speed.

- SLOW : Scroll speed is set to slow.
- FAST : Scroll speed is set to fast. (default)

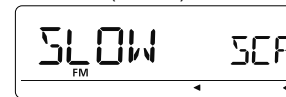
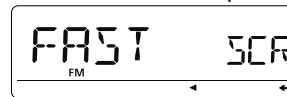

## ◇ Break-in function

BK

The break-in function allows you to break into a conversation where the two original stations are communicating with call sign squelch enabled. See pages 68, 69 for details.

- OFF : The break-in function is set to OFF. (default)
- ON : The break-in function is set to ON.  
- “BK” appears on the display.

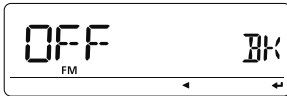

**NOTE:** The break-in function is turned OFF automatically when turning transceiver's power OFF

## ◇ EMR function

EMR

The EMR communication mode is available for digital mode operation. In the EMR communication mode, no call sign setting is necessary. When an EMR communication mode signal is received, the audio (voice) will be heard at the specified level even if the volume setting level is set to minimum level, or digital call sign/digital code squelch is in use. See page 67 for details.

- OFF : The EMR function is set to OFF. (default)
- ON : The EMR function is set to ON.  
- “EMR” appears on the display.

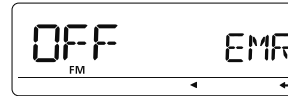

**NOTE:** The EMR communication function is turned OFF automatically when turning transceiver's power OFF

## 10 MENU SCREEN OPERATION

### ■ GPS mode items

#### ◇ GPS set

GPSSET

The following individual settings are available in GPS set. Set them to suit your GPS operation.

#### - Position format

P FORM

Selects the displaying position format from “mm.mm” (default) and “mm.SS.”

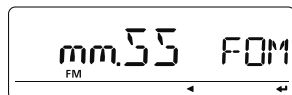

#### - Units

UNITS

Selects display units for distance and elevation to “m” or “Ft/ml.” (default : U.S.A. version; Ft/ml, Other versions; m)

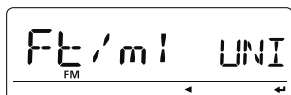

#### - UTC offset

UTC OFF

Sets time difference from UTC (Universal Time Coordinated) from -12:00 to +12:00 range in 5 min. steps. (default: 0:00)

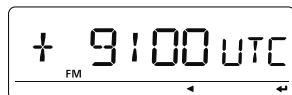
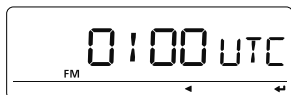

#### - GPS indication

INDIC

Sets the GPS indicator ON or OFF. (default : ON)

- OFF : “GPS” indicator does not appear.
- ON : “GPS” indicator appears on the display when a GPS receiver is connected and a valid position data is received; blinks when an invalid data is received.

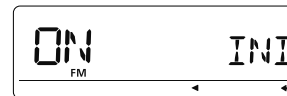
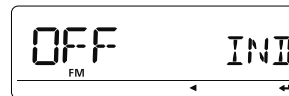

#### ◇ GPS TX mode items

GPS-TX

Sets the transmission of data from a connected GPS receiver ON or OFF.

When the position information is received from a connected GPS receiver and “GPS.ATX” (GPS Auto TX Timer) setting (p. 141) is set to a specific time, the transceiver automatically transmits the current position and message at the set interval.

- OFF : Transmitting position data is disabled. (default)
- DVG : Transmitting position data in GPS mode.
- DVA : Transmitting position data in GPS-A mode.

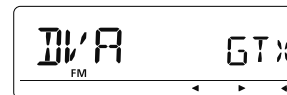
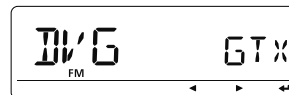

◆ **Sentence formatter setting**

- ① Select “DVG” in GPS transmission item, then push [↔](MONI) to enter the sentence formatter selection.
- ② Rotate [DIAL] to select the desired sentence formatter.
  - RMC, GGA, GLL, GSA, VTG and GSV are selectable.

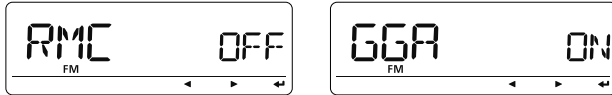

- ③ Push [↔](MONI) to enter the desired sentence formatter selection.
- ④ Rotate [DIAL] to select ON/OFF.

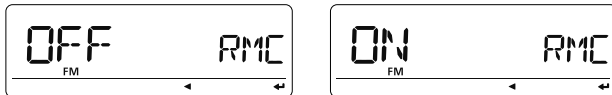

• **Default setting for sentence formatter**

Sentence formatter	Default	Sentence formatter	Default
RMC	OFF	GSA	OFF
GGA	ON	VTG	OFF
GLL	OFF	GSV	OFF

- ⑤ Push [↔](MONI) to store the selection.
- ⑥ Rotate [DIAL] to select next sentence and repeat steps ② to ⑤, or push [MENU] to return to frequency indication.
  - No more than four sentence formatters can be activate simultaneously.

◆ **GPS-A set mode**

Enter GPS-A set mode by selecting “DVA” in GPS TX mode, then push [↔](MONI). This set mode is available to set unproto address, data extension, time stamp, GPS-A symbol and comment.

- **Unproto address**

UNPROT

56 characters address can be entered for unproto address.

- ① Rotate [DIAL] to select “UNPROT” then push [↔](MONI) to enter the unproto address edit mode.
- ② Rotate [DIAL] to select the desired character.
  - “API880,DSTAR\*” is preset as the default.
  - The first character blinks.
  - Push [▶](LOW) to move the cursor right; push [◀](CS) to move the cursor left.
  - Push [CLR](DR) to erase the selected character, or push and hold [CLR](DR) for 1 sec. to erase all characters following the cursor.

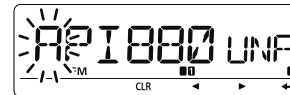

- ③ Repeat step ② until the desired unproto address is programmed.
- ④ Push [↔](MONI) to program the unproto address and return to the unproto address edit mode.
- ⑤ Push [◀](CS) to return to GPS-A set mode item indication.

## 10 MENU SCREEN OPERATION

### - DATA extension

DT EXT

Sets the data extension capability to "CUR.SPD" or OFF (default).

The transceiver's course and speed information is additionally transmitted with position data when "CUR.SPD" is selected.

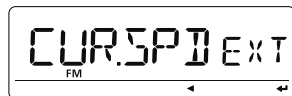
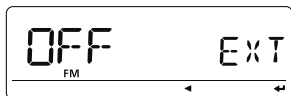

**NOTE:** When "CUR.SPD" is selected, number of character for "COMMENT" is limited to 36.

### - Time stamp

TIME

Selects transmitting time stamp type from DHM, HMS and OFF. This function transmits UTC (Universal Time Coordinated) time only.

- **OFF** : No time stamp is transmitted. (default)
- **DHM** : Time stamp in the format of Day, Hour and Minute is transmitted.
- **HMS** : Time stamp in the format of Hour, Minute and Second is transmitted.

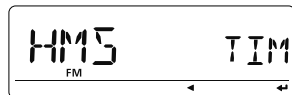
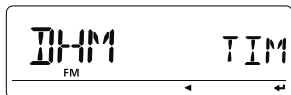

### - GPS-A symbol

SYMBOL

Selects the desired GPS-A symbol.

Available symbols: AMBU (Ambulance), BUS (Bus), FIRE (Fire Truck), BICYCL (Bicycle), YACHT (Yacht), HELI (Helicopter), AIRCRA (Small Aircraft), SHIP (Power Boat), CAR (Car: default), MCYCLE (Motorcycle), BALLOO (Balloon), JEEP (Jeep), RV (Recreational Vehicle), TRUCK (Truck), VAN (Van) and OTHER (Other).

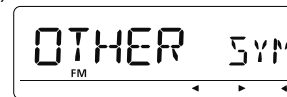
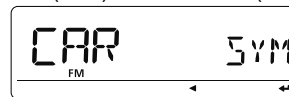

If "OTHER" is selected, set the desired symbol code as follows;

- ① Push [**←**](MONI) to begin programming.
  - 1st character blinks.
  - "--" blinks at the 1st character and "--" appears at the 2nd character if no symbol is programmed previously.

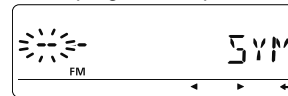

- ② Rotate [**DIAL**] to select the 1st character from "∞" and "/."
- ③ Push [**▶**](LOW) to select the 2nd digit.
- ④ Rotate [**DIAL**] to select the 2nd digit character.
  - A-Z (capital letters), 0-9, !, ", #, \$, %, &, ', (, ), \*, +, ,, -, ., /, :, ;, <, =, >, ?, @, [, \, ], ^ and space are available for 2nd character.

- ⑤ Push [↩](MONI) to program the symbol code, then exit programming.
- ⑥ Push [⏪](CS) to return to GPS-A set mode screen.

/// When “OTHER” is selected, check the symbol codes of APRS® and set it correctly.

**- Comment** COMMEN

Program up to a 43-character\* comment. The programmed comment is transmitted with the GPS position data.

\*Only 36 character are available when “CUR.SPD” (COURSE/SPEED) is selected in DT EXT (data extension).

- ① Push [↩](MONI) to enter programming.
- ② Rotate [DIAL] to select the desired character.
  - The selected character blinks.
  - Push [▶](LOW) to move the cursor right; push [◀](CS) to move the cursor left.
  - Push [CLR](DR) to erase the selected character, or push and hold [CLR](DR) for 1 sec. to erase the characters following the cursor.

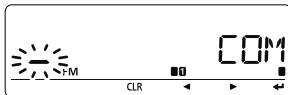

- ③ Repeat step ② until the desired comment is programmed.

- ④ Push [↩](MONI) to program the comment and exit comment programming.
- ⑤ Push [⏪](CS) to return to GPS-A set mode screen.

◇ **GPS auto transmission** GPSAT X

Selects the desired interval for automatic position transmission function from OFF (default), 5, 10, 30 second, 1, 3, 5, 10 and 30 minutes.

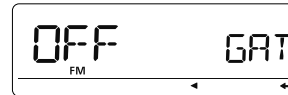

/// **NOTE:** When four sentence formatters are activated at the same time (“Sentence formatter setting” on page 139), “5SEC” cannot be selected.

# 11 DTMF MEMORY ENCODER

## ■ Programming a DTMF tone sequence

DTMF tone sequences are used for autopatching, accessing repeaters, controlling other equipment, etc. The transceiver has 16 DTMF memory channels (d0–d9, dA, dB, dC, dD, dE, dF) for storage of often-used DTMF tone sequences of up to 24 digits.

- ① Push and hold [DTMF](MONI) for 1 sec. to enter the DTMF set screen.
- ② Rotate [DIAL] to select “DTMF-M,” then push [↔](MONI).
- ③ Rotate [DIAL] to select the desired memory channel, then push [↔](MONI).
  - Previously programmed DTMF code is displayed if programmed.

- ④ Rotate [DIAL] to select the desired code.
- ⑤ Push [▶](LOW) to select the next digit.
  - Pushing [◀](CS) moves the cursor backward.
- ⑥ Repeat steps ④ and ⑤ until the desired DTMF tone sequence is input, then push [↔](MONI).
  - Up to 24 digit can be programmed.
- ⑦ Push [↔](MONI) to program the DTMF tone sequence and exit the programming mode.
- ⑧ Push [MENU] to exit the DTMF set screen.

**[EXAMPLE]:** Programming “5428A453” into DTMF memory channel “d4.”

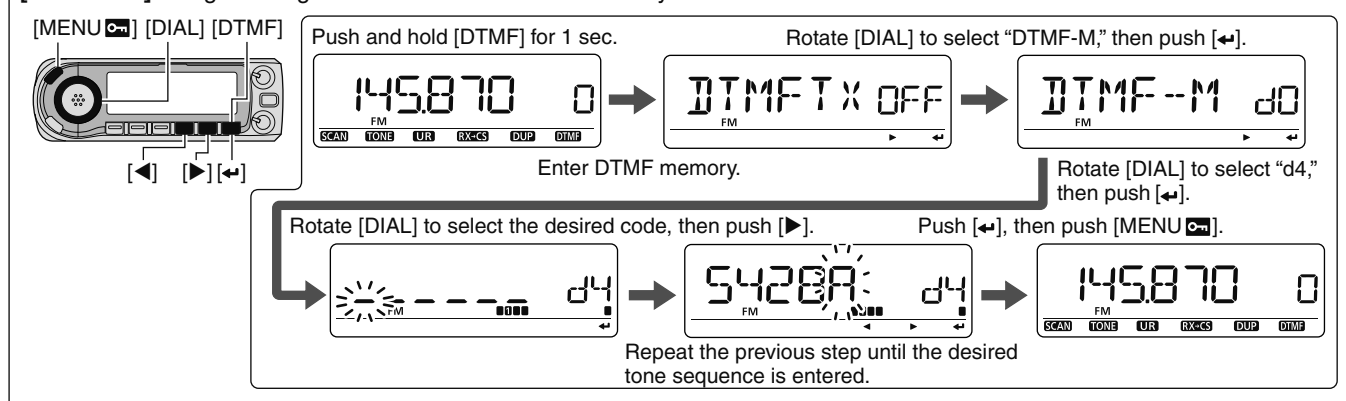



## ■ Transmitting a DTMF tone sequence

### ◇ Automatic transmission (DTMF memory)

- ① Push and hold [DTMF](MONI) for 1 sec. to enter the DTMF set screen.
- ② Rotate [DIAL] to select “DTMF-M,” then push [←](MONI) to enter DTMF memory screen.
- ③ Rotate [DIAL] to select the desired DTMF memory channel to be transmitted then push [←](CS).
  - Returns to the DTMF set screen.
- ④ Rotate [DIAL] to select “DTMF TX,” then push [←](MONI).
- ⑤ Rotate [DIAL] to select “ON,” then push [←](MONI).
- ⑥ Push [MENU] to exit from DTMF set screen.
  - “” appears in place of 100 MHz digit.
- ⑦ Push [PTT] to transmit the selected DTMF memory content.
- ⑧ To cancel the DTMF tone sequence automatic transmission, select “OFF” in step ⑤.
  - When the DTMF encoder is turned ON continuously, each push of the PTT transmits the previously selected DTMF tone sequence.





- ① Push [FUNC] then [Low 6(DTMF)] to turn the DTMF memory encoder ON.
  - “” appears in place of 100 MHz digit.
- ② Push [PTT] to transmit the previously selected DTMF memory.
- ③ Push [FUNC] then [SET B(D-OFF)] to cancel the DTMF memory encoder.
  - When the DTMF encoder is turned ON continuously, each push of the PTT transmits the previously selected DTMF tone sequence.

# 11 DTMF MEMORY ENCODER

## ◇ Transmitting a DTMF memory directly



- 1 Push [FUNC] then [LOW 6(DTMF)] to turn the DTMF memory encoder ON.
    - “” appears in place of 100 MHz digit.
  - 2 Push [DTMF-S] to turn the DTMF memory direct selection ON.
    - The function indicator (microphone) lights green.
  - 3 Push the desired DTMF channel.
    - “0” to “9,” “A” to “D,” “\*” and “#” are available for DTMF memory channels.
    - The selected DTMF tone sequence is automatically transmitted without pushing PTT.
-  **NOTE:** When no DTMF tone sequence programmed channel number is pushed, it transmits the relative DTMF tone sequence as the manual transmission described as at right.
- 4 Push [DTMF-S] again to deactivate the DTMF memory direct selection.
  - 5 Push [FUNC] then [SET B(D-OFF)] to cancel the DTMF memory encoder.

## ◇ Manual transmission



- 1 Deactivate the DTMF memory encoder by pushing [FUNC] then [SET B(D-OFF)].
- 2 Push [DTMF-S] to turn the DTMF direct selection ON.
  - The function indicator (microphone) lights green.
- 3 Push one of “0” to “9” and “A” to “F” keys momentarily, then push the desired DTMF keys, 0–9 and A to F.
  - A: [CLR A(MW)]      B: [SET B(D-OFF)],
  - C: [ENT C(T-OFF)]    D: [SQL▲ D(MUTE)],
  - E: [VOL▼ \*(TONE-1)] F: [SQL▼ #(16KEY-L)]
  - Automatically transmits without pushing PTT.
  - The first code entered may not be transmitted because transmitting takes 400 msec. to start. Then the DTMF code transmission starts from the 2nd code.
- 4 Push [DTMF-S] again to deactivate the DTMF direct selection.

## ■ DTMF speed

The rate at which DTMF values in memory send individual DTMF characters can be set to accommodate operating needs.

- ① Enter “DTMF-S” in the DUP.T menu.

MENU ⇄ DUP.T ⇄ **DTMF-S** (p. 122)  
(Push [MENU 

[MENU 

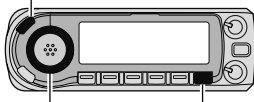

[DIAL]

[←]

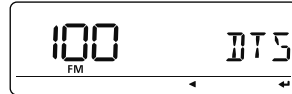
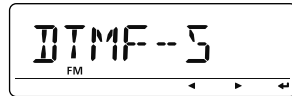

- ② Rotate [DIAL] to select and set the desired speed as shown in the table below, then push [←](MONI).  
③ Push [MENU 

DISPLAY	INTERVAL	SPEED
100	100 msec.	5.0 cps
200	200 msec	2.5 cps
300	300 msec.	1.6 cps
500	500 msec.	1.0 cps

cps=characters/sec

## ■ Clearing a DTMF memory

An unwanted DTMF memory can be cleared (erased).

- ① Push and hold [DTMF](MONI) for 1 sec. to enter the DTMF set screen.
- ② Rotate [DIAL] to select “DTMF-M,” then push [←](MONI).
- ③ Rotate [DIAL] to select the desired DTMF memory channel to be cleared, then push [←](MONI).
- ④ Rotate [DIAL] to select “--,” then push [←](MONI) to clear the selected DTMF memory channel.

When entering DTMF programming mode.



[DIAL]

[←]



Rotate [DIAL]

After clearing the DTMF memory.

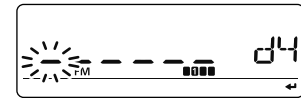

- ⑤ Push [MENU 

# 12 TONE SQUELCH AND POCKET BEEP

## ■ Tone/DTCS squelch (beep) operation

- ① Set the desired operating frequency and the desired operating mode.
- ② Set the desired CTCSS tone or DTCS code.  
See pages 147–149.
- ③ Push and hold **[TONE]**(M/CALL) for 1 sec. to enter the tone selection state.
- ④ Rotate **[DIAL]** to select the desired squelch system, then push **[TONE]**(M/CALL) again.
  - “(••) T SQL”: Tone squelch with pocket beep, “T SQL”: Tone squelch, “(••)DTCS”: DTCS squelch with pocket beep, “DTCS”: DTCS squelch



[DIAL] [TONE]

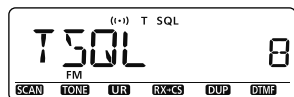

- ⑤ When a signal with the correct tone or code is received, the transceiver's mute is released and received audio sounds.
  - Emits beep tones for 30 sec. and blinks “(••)” if pocket beep is selected in step ④.
- ⑥ Push **[PTT]** to answer or push **[CS]** to stop the beeps and blinking.

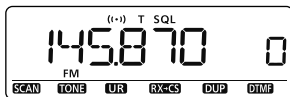

Pocket beep

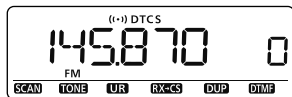

DTCS beep

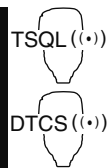

- ① Set the operating frequency.
- ② Push **[FUNC]** then push one of following keys to turn the desired squelch system ON.
  - **[HIGH 4(DTCS)]** : DTCS squelch
  - **[MID 5(DTCS ((••)))]** : DTCS squelch with pocket beep
  - **[DUP+ 8(TSQL ((••)))]** : Tone squelch with pocket beep
  - **[SIMP 9(TSQL)]** : Tone squelch
- ③ When a signal with the correct tone or code is received, the transceiver's mute is released and received audio sound.
  - Emits beep tones for 30 sec. and blinks “(••)” if pocket beep is selected in step ②.
- ④ Push **[PTT]** to answer or push **[CLR A(MW)]** to stop the beeps and blinking.
  - “(••)” disappears and cancels the pocket beep function automatically.
- ⑤ To cancel the tone squelch or DTCS squelch function, push **[FUNC]** then **[ENT C(T-OFF)]**.
  - “TSQL” or “DTCS” disappears

### NOTE:

- The tone/DTCS code squelch opens sometimes when other stations communicate using an adjacent tone frequency or in a DTCS code.
- The tone/DTCS code squelch can be operated on the FM or FM-N mode only.

### ◇ Reverse tone/DTCS squelch

The reverse tone/DTCS squelch is convenient if you want to ignore a specific signal.

- ① Set the desired operating frequency and the desired operating mode.
- ② Set the desired CTCSS tone or DTCS code.
- ③ Push and hold [TONE](M/CALL) for 1 sec. to enter the tone selection state, then push [TONE](M/CALL) again.
- ④ Rotate [DIAL] to select the desired squelch system.



Tone squelch reverse

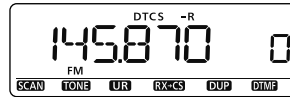

DTCS reverse

- ⑤ When a signal with unmatched tone or code is received, the transceiver's mute is released and the received audio sounds. The transceiver mutes the squelch when a signal with the matched tone or code is received.

### ◇ Setting tone squelch frequency

- ① Enter "C TONE" in the DUP.T menu.

MENU ⇨ DUP.T ⇨ **C TONE** (p. 121)  
 (Push [MENU], (rotate [DIAL], then push [←](MONI).)

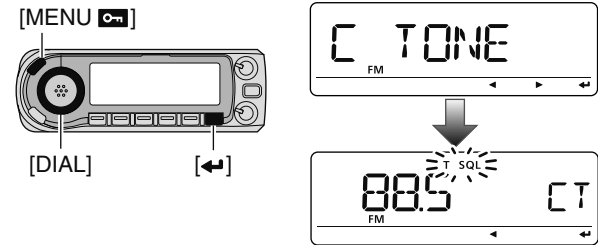

- ② Rotate [DIAL] to select and set the desired CTCSS tone frequency, then push [←](MONI).
  - Each operating band and each memory channel have independent settings.
  - See the table on page 148 for available tone frequencies.
- ③ Push [MENU] to exit the DUP.T menu screen.



- ① Enter "C TONE" in the DUP.T menu.

MENU ⇨ DUP.T ⇨ **C TONE** (p. 121)  
 (Push [SET B(D-OFF)] to enter the MENU screen, (Push [▲] or [▼], then push [SET B(D-OFF)].)

- ② Push [▲] or [▼] to select the desired tone frequency, then push [SET B(D-OFF)].
- ③ Push [CLR A(MW)] to exit the DUP.T menu screen.

## 12 TONE SQUELCH AND POCKET BEEP

### ◇ Setting DTCS code

- ① Enter "CODE" (DTCS code) in the DUP.T menu.

MENU ⇨ DUP.T ⇨ **CODE** (p. 122)  
 (Push [MENU 

- ② Rotate [DIAL] to select and set the desired DTCS code, then push [←](MONI).

- Each operating band and each memory channel have independent settings.
- See the table at right for available DTCS codes.

- ③ Push [MENU 

▨ DTCS phase can be selected in "DTCS-P" (DTCS polarity) item. (p. 122)



- ① Enter "CODE" (DTCS code) in the DUP.T menu.

MENU ⇨ DUP.T ⇨ **CODE** (p. 122)  
 (Push [SET B(D-OFF)] to enter the MENU screen,  
 (Push [▲] or [▼], then push [SET B(D-OFF)].)

- ② Push [▲] or [▼] to select the desired DTCS code, then push [SET B(D-OFF)].  
 ③ Push [CLR A(MW)] to exit the DUP.T menu screen.

#### • Available tone frequencies

67.0	79.7	94.8	110.9	131.8	156.7	171.3	186.2	203.5	229.1
69.3	82.5	97.4	114.8	136.5	159.8	173.8	189.9	206.5	233.6
71.9	85.4	100.0	118.8	141.3	162.2	177.3	192.8	210.7	241.8
74.4	88.5	103.5	123.0	146.2	165.5	179.9	196.6	218.1	250.3
77.0	91.5	107.2	127.3	151.4	167.9	183.5	199.5	225.7	254.1

#### • Available DTCS codes

023	054	125	165	245	274	356	445	506	627	732
025	065	131	172	246	306	364	446	516	631	734
026	071	132	174	251	311	365	452	523	632	743
031	072	134	205	252	315	371	454	526	654	754
032	073	143	212	255	325	411	455	532	662	
036	074	145	223	261	331	412	462	546	664	
043	114	152	225	263	332	413	464	565	703	
047	115	155	226	265	343	423	465	606	712	
051	116	156	243	266	346	431	466	612	723	
053	122	162	244	271	351	432	503	624	731	

## ■ DTCS polarity setting

- ① Enter “DTCS-P” (DTCS polarity) in the DUP.T menu.

MENU ⇄ DUP.T ⇄ **DTCS-P** (p. 122)  
 (Push [MENU , (rotate [DIAL], then push [←](MONI).)

[MENU 



[DIAL]

[←]

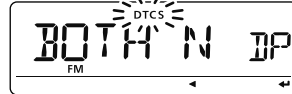
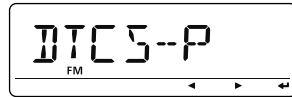

- ② Rotate [DIAL] to select and set the desired DTCS polarity, then push [←](MONI).
- **BOTH N** : Normal phase is used for both TX and RX. (Default)
  - **TN-RR** : Normal phase is used for TX; Reverse phase for RX.
  - **TR-RN** : Reverse phase is used for TX; Normal phase for RX.
  - **BOTH R** : Reverse phase is used for both TX and RX.
- ③ Push [MENU ] to exit the DUP.T menu screen.



- ① Enter “DTCS-P” (DTCS polarity) in the DUP.T menu.

MENU ⇄ DUP.T ⇄ **DTCS-P** (p. 122)  
 (Push [SET B(D-OFF)] to enter the MENU screen),  
 (Push [▲] or [▼], then push [SET B(D-OFF)].)

- ② Push [▲] or [▼] to select the desired polarity, then push [SET B(D-OFF)].
- ③ Push [CLR A(MW)] to exit the DUP.T menu screen.

## 12 TONE SQUELCH AND POCKET BEEP

### ■ Tone scan

By monitoring a signal that is being operated with pocket beep, tone or DTCS squelch function, you can determine the tone frequency or DTCS code necessary to open the squelch.

- ① Set the desired operating frequency and the desired operating mode.
- ② Push and hold **[TONE]**(M/CALL) for 1 sec. to enter the tone selection state.
- ③ Rotate **[DIAL]** to select either “TONE,” “TSQL” or “DTCS” to be scanned, then push **[TONE]**(M/CALL) again.
- ④ Push and hold **[SCAN]**(VFO/MHz) to enter scan selection state.
  - To change the scanning direction, rotate **[DIAL]**.
- ⑤ Rotate **[DIAL]** to select “TONE,” then push **[SCAN]**(VFO/MHz) again to start the tone scan.

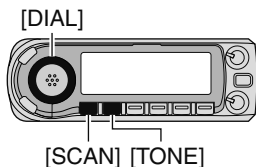

During repeater tone scan

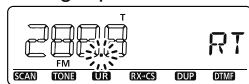

During CTCSS frequency scan

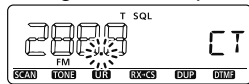

During DTCS code scan

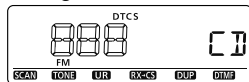

- ⑥ When the CTCSS tone frequency or 3-digit DTCS code is matched, the squelch opens and the tone frequency is temporarily programmed into the selected feature, such as memory or call channel.
  - The tone scan pauses when a CTCSS tone frequency or 3-digit DTCS code is detected.
  - The decoded CTCSS tone frequency or 3-digit DTCS code is used for the tone encoder or tone encoder/decoder, depending on the selected tone condition or type in step ③.
    - “TONE” : Tone encoder for repeater operation
    - “TSQL” : CTCSS tone encoder/decoder
    - “DTCS” : DTCS tone encoder/decoder
- ⑦ Push **[SCAN]**(VFO/MHz) to stop the scan.



- ① Set the frequency or memory channel to be checked for a tone frequency.
- ② Selects the tone type to be scanned.
  - Push **[FUNC]** then push; **[SIMP 9(TSQL)]** for tone squelch; **[HIGH 4(DTCS)]** for DTCS squelch.
- ③ Push **[FUNC]** then **[SCAN 2(T-SCAN)]** to start the tone scan.
- ④ When the tone frequency is matched, the squelch opens and the tone frequency is programmed into the selected mode, such as memory or call channel.
- ⑤ Push **[CLR A(MW)]** to stop the scan.

**NOTE:** The decoded tone frequency is programmed temporarily when a memory or call channel is selected. However, this will be cleared when the memory/call channel is re-selected.



## ■ Digital squelch

**NOTE:** Use digital code squelch when operating with two or more stations, because the digital call sign squelch function recognizes “MY” (your own call sign). Thus the digital call sign squelch function can be used when operating with only one station.

- ① Set the desired operating frequency in the DV mode.
- ② Set the current call signs, “MY” (your own call sign) and “UR” (other station call sign) and/or Digital code. See next page.
- ③ Push and hold **[TONE]**(M/CALL) for 1 sec. to enter the tone selection state.
- ④ Rotate **[DIAL]** to activate the digital code or digital call sign squelch, then push **[TONE]**(M/CALL) again.
  - Digital call sign beep “((•)) D SQL,” Digital call sign squelch “D SQL,” Digital code beep “((•)) CSQL” and Digital code squelch “CSQL” appears in order.

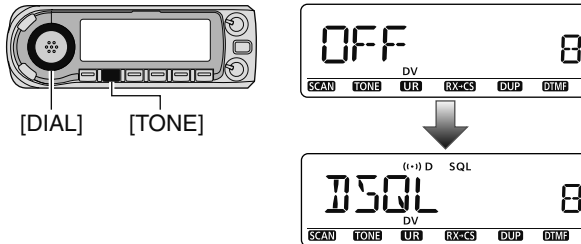

- ⑤ When the received signal includes a matching call sign/code, the squelch opens and the signal can be heard.
  - When the received signal’s call sign/code does not match, digital call sign/digital code squelch does not open; however, the S-indicator shows signal strength.
  - Emits beep tones for 30 sec. and blinks “((•))” if pocket beep is selected in step ④.



Digital call sign pocket beep



Digital code pocket beep



Digital call sign squelch



Digital code squelch

## 12 TONE SQUELCH AND POCKET BEEP

### ◇ UR and MY call signs setting

- ① Enter "UR" in call sign screen.

MENU ⇨ CALL-S ⇨ **UR**

(Push [MENU 

② Rotate [DIAL] to select the desired call sign.

- Input the call sign if the desired call sign has not stored in the call sign memory. See p. 32 for details.



- ③ Push [←](MONI) to set the selected call sign to the current UR call sign.

- ④ Rotate [DIAL] to select "MY" in call sign screen, then push [←](MONI).

MENU ⇨ CALL-S ⇨ **MY**

(Push [MENU 

⑤ Rotate [DIAL] to select the desired call sign.

- Input the call sign if the desired call sign has not stored in the call sign memory. See p. 31 for details.



- ⑥ Push [←](MONI) to set the selected call sign to the current MY call sign.

### ◇ Digital code setting

- ① Enter "D CODE" (DTCS CODE) in the DUPT menu.

MENU ⇨ DUPT ⇨ **D CODE** (p. 122)

(Push [MENU 

[MENU 

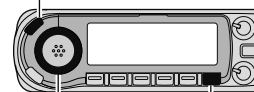

[←]

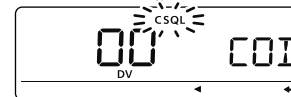

- ② Rotate [DIAL] to select and set the desired digital code (00–99), then push [←](MONI).

- Each operating band and each memory channel have independent settings.

- ③ Push [MENU 

152

## ■ Microphone keys

The supplied HM-133's [F-1] and [F-2] keys memorize the transceiver conditions.

The [UP]/[DN] keys of the standard or an optional microphone (other than the HM-133) can be assigned functions like the function keys on the transceiver's front panel.

### ◇ [F-1]/[F-2] keys on the HM-133

The following conditions can be memorized into [F-1] and [F-2] keys, independently.

Operating frequency, Operating mode selection (FM/FM-N/AM/AM-N/DV), Repeater setting (offset direction and frequency offset, tone ON/OFF and tone frequency), Tuning step, Tone/DTCs squelch (ON/OFF, frequency/code and polarity), Call signs (station and repeater1/2), Call sign/digital code squelch (ON/OFF and digital code)

The set mode settings or transmit output power level can additionally be memorized with [FUNC]+[F-1]/[F-2] key operation, independently.

SCAN set mode settings (except program scan link settings), FUNC set mode settings (except Mic UP/DN settings), DISP set mode settings, SOUNDS set mode settings, DV SET mode settings (except BK or EMR settings), GPS.SET settings, GPS alarm areas (ALM1, ALM2), Sentence formatter settings, GPS-A set mode settings, Transmit output power level

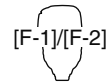

#### ➤ **Programming the band condition**

Set the desired contents of each condition, then push and hold [F-1]/[F-2] for 1 sec.

- 3 beeps sound.

#### ➤ **Recalling the band condition**

Push [F-1]/[F-2] momentarily.

#### ➤ **Programming the bands condition ([FUNC]+)**

After setting the desired contents of each condition, push [FUNC] then push and hold [F-1]/[F-2] for 1 sec.

- 3 beeps sound.

#### ➤ **Recalling the bands condition ([FUNC]+)**

Push [FUNC] then push [F-1]/[F-2] momentarily.

### ◇ [UP]/[DN] keys on a microphones (other than the HM-133)

The following functions are assigned to the [UP]/[DN] keys on the other microphones (HM-103/HM-154) in set mode.

#### • **Default setting**

[UP] : channel up; push and hold to start scan, push again to stop scan.

[DN] : channel down; push and hold to start scan, push again to stop scan.

See page 129 for assignable function details.

## 13 OTHER FUNCTIONS

### ■ All reset

AT POWER ON

The function display may occasionally display erroneous information (e.g. when first applying power). This may be caused externally by static electricity or by other factors.

If this problem occurs, turn power OFF. After waiting a few seconds, turn power ON again. If the problem persists, perform the following procedure.

• Partial reset is also available. See right for details.

#### /// **IMPORTANT!:**

Resetting the CPU **CLEARs** all programmed contents to their default settings.

- ① Push and hold [⏻] for 1 sec. to turn power OFF.
- ② Push and hold simultaneously [MENU] and [S.MW], then turn power ON to reset the CPU.

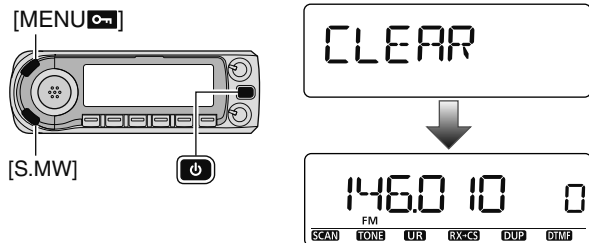

### ■ Partial reset

AT POWER ON

If you want to initialize the operating conditions (VFO frequency, VFO settings, menu group's contents) without clearing the memory contents, call sign memories or repeater lists, a partial reset function is available.

- ① Push and hold [⏻] for 1 sec. to turn power OFF.
- ② Push and hold simultaneously [S.MW] and [VFO/MHz], then turn power ON to reset the CPU.

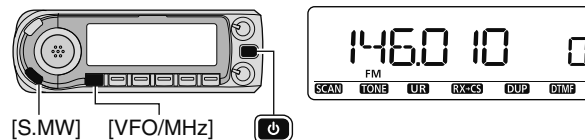

After resetting, the displayed frequency depends on versions.

## ■ Data cloning

AT POWER ON

### ◇ Cloning between transceivers

The ID-880H has transceiver-to-transceiver data cloning capability. This function is useful when you want to copy all of the programmed contents from one ID-880H to another.

- A optional OPC-474 CLONING CABLE is required.

- ① Connect the optional OPC-474 cloning cable to the [SP] jack of the master and sub-transceivers.
  - The master transceiver is used to send data to the sub-transceiver.

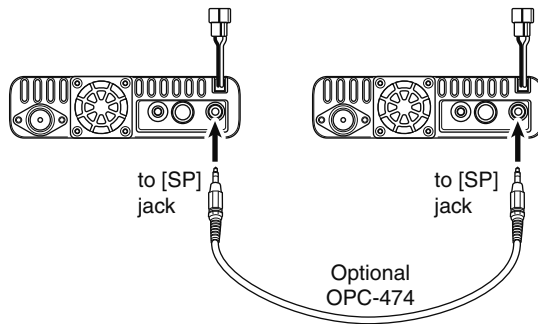

- ② While pushing and holding [M/CALL], turn power ON to enter cloning mode (master transceiver only— power on only for sub-transceiver).
  - “CLONE” appears and the transceivers enter the clone standby condition.

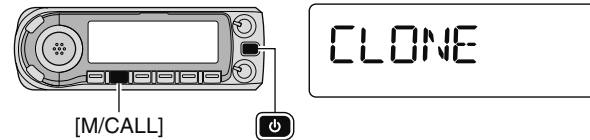

- ③ Push [M/CALL] on the master transceiver.
  - “CL OUT” appears in the master transceiver’s display and the bar meter shows that data is being transferred to the sub-transceiver.
  - “CL IN” appears automatically in the sub-transceiver’s display and the bar meter shows that data is being received from the master transceiver.

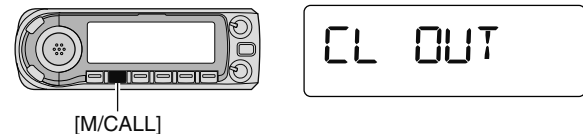

- ④ When cloning is finished, turn power OFF, then ON to exit cloning mode.
  - “CL END” appears automatically in the sub-transceiver’s display after the cloning is completed.

## 13 OTHER FUNCTIONS

### ◇ Cloning using a personal computer

The CS-80/880 CLONING SOFTWARE (free download) is also available to clone/edit contents with a PC (for Microsoft® Windows® 2000/XP or Windows Vista®) using ICF format files. To connect the transceiver and a PC, either the optional data communication cable; OPC-1529R or cloning cable; OPC-478/478UC is required.

- Using the OPC-1529R

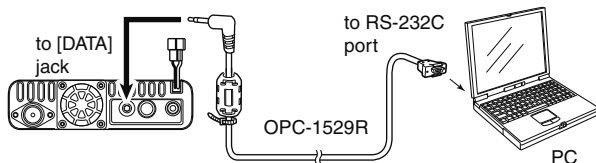

- Using the OPC-478/478UC

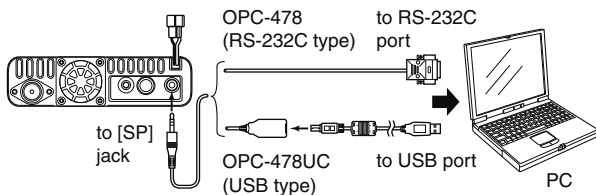

**NOTE:** If you want to clone by connecting the optional data communication cable (OPC-1529R) to the [DATA] jack, set "DATATX" (DV data TX) to "PTT" (p. 134). Otherwise data cloning may not work properly.

### ◇ Cloning error

**NOTE: DO NOT** push any key on the transceiver (to be cloned) during cloning. This will cause a cloning error.

When the display appears as below, a cloning error has occurred.

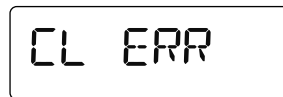

If this happens, turn the transceiver (to be cloned) power OFF then ON again and cloning must be repeated.

## ■ Auto power OFF

The transceiver can be set to automatically turn OFF after a specified period with a beep when no switch is pushed.

120 min., 90 min., 60 min., 30 min. and OFF can be specified. The specified period is retained even when the transceiver is turned OFF by the auto power-off function. To cancel the function, select “OFF” in the auto power-off item in set mode.

This can be selected with “AP OFF” in the FUNC set mode (SET).

MENU ⇨ SET ⇨ FUNC ⇨ **AP OFF** (p. 130)  
(Push [MENU ]), (rotate [DIAL]), then push [←](MONI).)

## ■ Time-out timer

To prevent accidental prolonged transmission, etc., the transceiver has a time-out timer. This timer cuts a transmission OFF after 1, 3, 5, 10, 15 or 30 min. of continuous transmission. This timer can be cancelled (default).

/// Approx. 10 sec. before the time-out timer is activated, the transceiver emits a beep tone as a warning.

This can be selected with “TOT” in the FUNC set mode (SET).

MENU ⇨ SET ⇨ FUNC ⇨ **TOT** (p. 128)  
(Push [MENU ]), (rotate [DIAL]), then push [←](MONI).)

## ■ Packet operation

### ◇ Data speed

For packet operation, the transceiver can be set to one of two data speeds: 1200 bps (default) or 9600 bps.

- ① Enter “PACKET” in the FUNC set mode (SET).

MENU ⇨ SET ⇨ FUNC ⇨ **PACKET** (p. 129)  
(Push [MENU ]), (rotate [DIAL]), then push [←](MONI).)



[MENU ] [DIAL] [←]



- ② Rotate [DIAL] to select the desired data transmission speed from 1200 bps (default) and 9600 bps, then push [←](MONI).
- ③ Push [MENU ] to exit the FUNC set mode.

- The microphone signal is automatically cut. Therefore, it is not necessary to disconnect the microphone plug from the connector in this case.
- When pushing [PTT] during data transmission, data transmission is interrupted and voice signals have priority.

## 13 OTHER FUNCTIONS

### ◇ Packet jack pin assignment

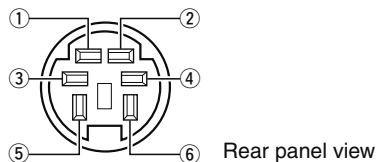

#### ① DATA IN

Input terminal for data transmit. See previous page for details on how to toggle data speed between 1200 (AFSK) and 9600 bps (G3RUH, GMSK).

#### ② GND

Common ground for DATA IN, DATA OUT and AF OUT.

#### ③ PTT P

PTT terminal for packet operation only. Connect ground to transmit data.

#### ④ DATA OUT

Data out terminal for 9600 bps operation only.

#### ⑤ AF OUT

Data out terminal for 1200 bps operation only.

#### ⑥ P SQL

Output is high (+5 V) when the transceiver receives a signal which opens the squelch.

- To avoid unnecessary TNC transmission, connect squelch to the TNC to inhibit transmission when receiving signals.
- Keep audio output at a normal level, otherwise a “P SQL” signal will not be output.

### ◇ 1200 bps packet operation

① Connect the transceiver and a TNC as illustrated below.

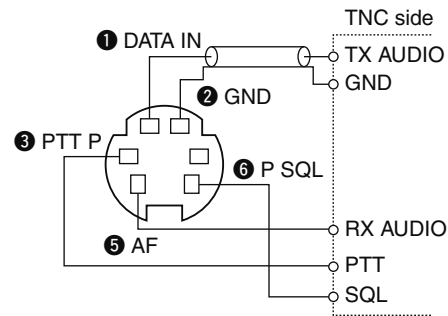

② Set the TNC for transmit.

③ Set transmit delay on the TNC to 50–100 msec., if available.

④ Adjust the TNC frequency deviation if necessary.

#### • When using a deviation meter:

Adjust the output of the TNC so that frequency deviation is in the range  $\pm 3$  to  $\pm 4$  kHz.

#### • When NOT using a deviation meter:

A receiver or transceiver is needed to monitor the transmission—compare the received audio output level when receiving a TNC modulated signal with high level voice signals using the microphone. Then adjust the TNC modulated signal to a lower level than the voice modulated signal.



- Read the instructions supplied with your TNC carefully before attempting packet operation with the transceiver.
- Pin ⑤ AF OUT is for 1200 bps operation only. This pin cannot be used for 9600 bps operation.
- Over modulation may degrade signal quality. If you find that many transmissions are failing, re-adjust the modulation level.

## 13 OTHER FUNCTIONS

### ◇ 9600 bps high speed packet operation

The transceiver supports 2 modes of 9600 bps packet operation: G3RUH and GMSK.

① Connect the transceiver and a TNC as illustrated below.

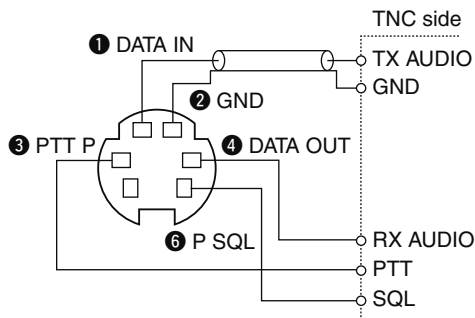

- ② G3RUH mode can handle 16 kinds of modulated wave forms in order to maintain a communication link.
- ③ Set transmit delay on the TNC to 50–100 msec., if available.
- ④ Adjust the TNC frequency deviation if necessary (see next page).

- When using the PTT P terminal for packet operation, no voice signals are transmitted from the microphone.
- When pushing [PTT] during data transmission, data transmission is interrupted and the voice signal takes priority.
- Read the instructions supplied with your TNC carefully before attempting packet operation with the transceiver.
- Pin ④ DATA OUT is for 9600 bps operation only. This pin cannot be used for 1200 bps operation.

## ◇ Adjusting the transmit signal output from the TNC

When setting data transmission speed to 9600 bps, the data signal coming from the TNC is applied exclusively to the internal limiter circuitry to automatically maintain band width.

**NEVER** apply data levels from the TNC of over 0.6 V p-p, otherwise the transceiver will not be able to maintain the band width and may possibly interfere with other stations.

### 1. When using a level meter or oscilloscope, adjust the TX audio output level (DATA IN level) from the TNC as follows.

0.4 V p-p (0.2 V rms) : recommended level

0.2 V p-p–0.5 V p-p (0.1–0.25 V rms) : acceptable level

### 2. When NOT using a measuring device.

- ① Connect the transceiver to a TNC.
- ② Enter a test mode (“CALL”, etc.) on the TNC, then transmit some test data.
- ③ *When the transceiver fails to transmit the test data or transmits sporadically (TX indicator doesn't appear or flashes):*
  - Decrease the TNC output level until the transmit indicator lights continuously.*When transmission is not successful even though the TX indicator lights continuously:*
  - Increase the TNC output level.

## 13 OTHER FUNCTIONS

### ■ Weather channel operation

#### ◇ Weather channel selection

- ① Push **[M/CALL]** several times to select weather channel group.



[M/CALL]

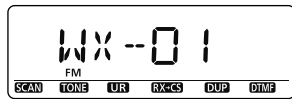

Weather channel group indication

- ② Rotate **[DIAL]** to select the desired weather channel.
- ③ Push **[M/CALL]** to select the memory mode, or push **[VFO/MHz]** to select the VFO mode.

/// Push and hold **[SCAN]**(VFO/MHz) for 1 sec. activates the weather channel scan. Push **[SCAN]**(VFO/MHz) again to stop the scan.

USA/CHN/EXP versions only

#### ◇ Weather alert function

NOAA broadcast stations transmit weather alert tones before important weather announcements. When the weather alert function is turned ON, the selected weather channel is monitored every 5 sec. so you can hear weather announcements. When the alert signal is detected, the "ALT" and the WX channel indications are displayed alternately and a beep sounds until the transceiver is operated. The previously selected (used) weather channel is checked periodically during standby or while scanning.

- ① Select the desired weather channel.
- ② Enter "WX-ALT" in the SCAN set mode.

MENU ⇨ SCAN ⇨ **WX-ALT** (p. 63)  
(Push **[MENU]**), (rotate **[DIAL]**, then push **[←]**(MONI).)

- ③ Rotate **[DIAL]** to select "ON" or "OFF."
- ④ Push **[←]**(MONI) to return to the SCAN set mode, and push **[MENU]** to return to the weather channel indication.
- ⑤ Sets the desired stand-by condition.
  - Selects the VFO, memory or call channel.
  - Scan or priority watch operation can also be selected.

- ⑥ When the alert is detected, a beep sounds and the following indication is displayed.

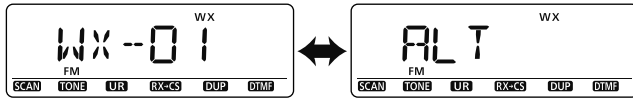

The display shows above indications alternately.

- ⑦ Turn the weather alert function OFF in SCAN set mode.

**NOTE:** While receiving a signal on a frequency other than the weather alert frequency, the receiving signal will be interrupted momentarily approximately every 5 sec. when the Weather alert function is ON. These interruptions cease when the Weather alert function is turned OFF.

# 14 MAINTENANCE

## ■ Troubleshooting

If your transceiver seems to be malfunctioning, please check the following points before sending it to a service center.

PROBLEM	POSSIBLE CAUSE	SOLUTION	REF.
Does not turn on.	<ul style="list-style-type: none"> <li>• Power connector has a poor contact.</li> <li>• Polarity of the power connection is reversed.</li> <li>• Blown fuse.</li> </ul>	<ul style="list-style-type: none"> <li>• Check the connector pins.</li> <li>• Reconnect the power cable observing the proper polarity. Replace the fuse if damaged.</li> <li>• Correct the cause, then replace the fuse.</li> </ul>	— pgs. VI, 165 p. 165
No sound comes from the speaker.	<ul style="list-style-type: none"> <li>• Volume is too low.</li> <li>• The audio mute function is activated.</li> <li>• Squelch is set too high.</li> <li>• A selective call or squelch function is activated such as pocket beep or tone squelch.</li> </ul>	<ul style="list-style-type: none"> <li>• Rotate [VOL] clockwise.</li> <li>• Push any key to deactivate it.</li> <li>• Set the squelch level to the threshold.</li> <li>• Turn the appropriate function OFF.</li> </ul>	p. VIII p. 20 p. VIII pgs. 146, 151
Sensitivity is low and only strong signals are audible.	<ul style="list-style-type: none"> <li>• Antenna feedline or the antenna connector has a poor contact or is short circuited.</li> <li>• Squelch attenuator function is activated.</li> </ul>	<ul style="list-style-type: none"> <li>• Check, and if necessary, replace the feed line or solder the antenna connector again.</li> <li>• Set [SQL] between 10–12 o'clock position.</li> </ul>	p. VII p. 19
No contact possible with another station.	<ul style="list-style-type: none"> <li>• The other station is using tone squelch.</li> <li>• The transceiver is set to duplex.</li> </ul>	<ul style="list-style-type: none"> <li>• Turn the tone squelch function ON.</li> <li>• Set to simplex.</li> </ul>	p. 146 p. 23
Repeater cannot be accessed.	<ul style="list-style-type: none"> <li>• Wrong frequency offset is programmed.</li> <li>• Wrong subaudible tone frequency is programmed.</li> </ul>	<ul style="list-style-type: none"> <li>• Correct the frequency offset.</li> <li>• Correct the subaudible tone frequency.</li> </ul>	p. 27 p. 25
Frequency cannot be set.	<ul style="list-style-type: none"> <li>• The frequency lock function is activated.</li> </ul>	<ul style="list-style-type: none"> <li>• Turn the function OFF.</li> </ul>	p. 16
Frequency cannot be set via the microphone.	<ul style="list-style-type: none"> <li>• The frequency lock function is activated.</li> <li>• The microphone keypad lock function is activated.</li> </ul>	<ul style="list-style-type: none"> <li>• Turn the function OFF</li> <li>• Push [FUNC] then [SQL▼#(16KEY-L)] to deactivate the microphone keypad lock function.</li> </ul>	p. 16 p. 16
Some memory channels cannot be selected via the tuning dial.	<ul style="list-style-type: none"> <li>• The memory channel number has not been programmed yet.</li> </ul>	<ul style="list-style-type: none"> <li>• Select the channel via the microphone keypad to check whether the channel has been programmed or not.</li> </ul>	—

PROBLEM	POSSIBLE CAUSE	SOLUTION	REF.
Scan does not operate.	<ul style="list-style-type: none"> <li>The squelch is open.</li> <li>Only one memory channel is programmed or other channels are set as skip channels.</li> </ul>	<ul style="list-style-type: none"> <li>Set the squelch to the threshold point.</li> <li>Program other memory channels or cancel the memory skip function in the desired channels.</li> </ul>	p. VIII pgs. 90, 108
Transmission is automatically cut off.	<ul style="list-style-type: none"> <li>Time-out timer is activated.</li> </ul>	<ul style="list-style-type: none"> <li>Set the timer to OFF.</li> </ul>	p. 157
Transmission continues even when the PTT is released.	<ul style="list-style-type: none"> <li>One-touch PTT function is activated.</li> </ul>	<ul style="list-style-type: none"> <li>Turn the function OFF.</li> </ul>	p. 21
During tone squelch operation, the received audio breaks off at the other station.	<ul style="list-style-type: none"> <li>Transmitter's microphone gain is too high.</li> </ul>	<ul style="list-style-type: none"> <li>Select low microphone sensitivity in the FUNC set mode.</li> <li>Turn the ALC function ON in the FUNC set mode.</li> </ul>	p. 127 p. 127
The function display shows erroneous information.	<ul style="list-style-type: none"> <li>The CPU is malfunctioning.</li> </ul>	<ul style="list-style-type: none"> <li>Reset the CPU.</li> </ul>	p. 154

## ■ Fuse replacement

If the fuse blows or the transceiver stops functioning, find the source of the problem if possible, and replace the blown fuse with a new, properly rated one (FGB 20 A) as shown at right.

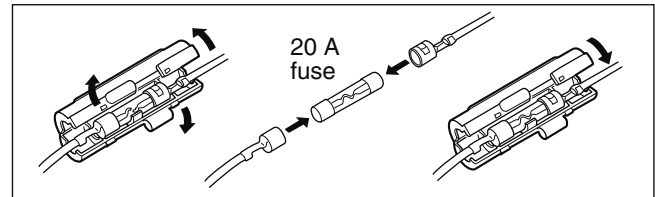

# 15 SPECIFICATIONS

## ◇ GENERAL

- Frequency coverage : (unit: MHz)

Version	TX	RX
U.S.A.	144–148, 430–450	118–173.995* <sup>1</sup> , 230–549.995* <sup>2</sup> , 810–823.990* <sup>4</sup> , 849–868.990* <sup>4</sup> , 894–999.990* <sup>4</sup>
CHN EXP	136–173.995* <sup>1</sup> , 400–469.995* <sup>3</sup>	118–173.995* <sup>1</sup> , 230–549.995* <sup>3</sup> , 810–999.990* <sup>4</sup>
KOR	144–146, 430–440	144–146, 430–440
AUS	144–148, 430–440	144–148, 430–440
TPE	144–146, 430–432	144–146, 430–432

\*<sup>1</sup>Guaranteed 144–148 MHz only, \*<sup>2</sup>Guaranteed 430–450 MHz only,

\*<sup>3</sup>Guaranteed 430–440 MHz only, \*<sup>4</sup>Not Guaranteed

- Type of emission : FM, AM (Receive only), DV
- Number of memory channels : 1052 (incl. 50 scan edges and 2 calls)
- Frequency resolution : 5<sup>‡</sup>, 6.25<sup>‡</sup>, 8.33<sup>‡</sup>, 10, 12.5, 15<sup>‡</sup>, 20, 25, 30, 50, 100, 125, 200 kHz

<sup>‡</sup>Selectable depending on the operating frequency band.

- Operating temperature range : –10°C to +60°C; +14°F to +140°F
- Frequency stability : ±2.5 ppm (–10°C to +60°C)
- Power supply requirement : 13.8 V DC ±15%
- Current drain (at 13.8 V DC: approx.):

Transmit	at 50 W	VHF: 11.5 A*
		UHF: 12.5 A*

\* 8.0 A (at 25 W) only for the TPE version

Receive	standby	0.9 A
(simultaneous receive)	max. audio	1.2 A

- Antenna connector : SO-239 (50 Ω)
- Dimensions (proj. not included) : 150(W) × 40(H) × 199.2(D) mm  
5<sup>29/32</sup>(W) × 1<sup>9/16</sup>(H) × 7<sup>27/32</sup>(D) in
- Weight (approx.) : 1.3 kg; 2 lb 14 oz (not incl. cable)

## ◇ TRANSMITTER

- Modulation system : FM  
DV (Digital) : Variable reactance frequency modulation  
GMSK reactance frequency modulation
- Output power : 50/15/5 W\* (approx.)  
\*25/15/5 W only for the TPE version.
- Max. frequency deviation : ±5.0 kHz (wide)  
±2.5 kHz (narrow)
- Spurious emissions : Less than –60 dB
- Microphone connector : 8-pin modular (600 Ω)

## ◇ RECEIVER

- Receive system : Double conversion superheterodyne
- Intermediate frequencies : 1st: 46.35 MHz, 2nd: 450 kHz
- Sensitivity (amateur bands only):  
FM (12 dB SINAD) : Less than 0.18 μV  
DV (BER 1%) : Less than 0.35 μV
- Squelch sensitivity<sup>†</sup> (threshold) : Less than 0.13 μV
- Selectivity<sup>†</sup> (typical) :  
Wide : More than 10 kHz/6 dB  
Less than 30 kHz/60 dB  
Narrow : More than 6 kHz/6 dB  
Less than 20 kHz/60 dB  
DV : More than 50 dB
- Spurious and image rejection<sup>†</sup> : More than 60 dB
- AF output power<sup>†</sup> (at 13.8 V DC) : More than 2.0 W at 10% distortion with an 8 Ω load
- Ext. speaker connectors : 3-conductor 3.5 (d) mm (1/8")/8 Ω

<sup>†</sup>Guaranteed 144–146 or 144–148 MHz and 430–440 or 440–450 MHz ranges only.

All stated specifications are subject to change without notice or obligation.



- Sensitivity (for RX bands— FM/AM; for your reference only):

Frequency range	FM ( $\mu\text{V}$ ) typical (12dB SINAD)	AM ( $\mu\text{V}$ ) typical (10dB S/N)
118–136.995 MHz	0.16	0.5
137–173.995 MHz	0.16	0.5
230–259.995 MHz	0.56	1.8
260–299.995 MHz	0.32	1
300–349.995 MHz	0.22	0.79
350–399.995 MHz	0.22	0.63
400–499.995 MHz	0.16	0.56
500–549.995 MHz	0.16	0.56
810–879.990 MHz	0.45	N/A
880–999.990 MHz	0.45	N/A

# 16 OPTIONS

## **CS-80/880** CLONING SOFTWARE (free download)

Use this software to program settings such as memory channels and set mode contents quickly and easily via your PC's RS-232C terminal (using OPC-1529R or OPC-478), or USB port (OPC-478UC). Either OPC-1529R, OPC-478 or OPC-478UC is required.

This software can be downloaded from the Icom home page via the Internet. Access the following URL to download the software and the manual.

<http://www.icom.co.jp/world/support/index.html>

## **HM-103/154** HAND MICROPHONE

## **HM-133** REMOTE-CONTROL MICROPHONE

Remote control microphone with key backlight. Same as that supplied with the transceiver.

## **OPC-347/1132** DC POWER CABLES

OPC-347 : 7.0 m; 27 ft<sup>†</sup>

OPC-1132 : 3.0 m; 11.2 ft<sup>†</sup>

Same as that supplied with the transceiver.

## **OPC-440/647** MIC EXTENSION CABLE

OPC-440: 5.0 m; 16.4 ft<sup>†</sup>

OPC-647: 2.5 m; 8.2 ft<sup>†</sup>

## **OPC-441** SPEAKER EXTENSION CABLE

5.0 m; 16.4 ft<sup>†</sup>

## **OPC-474** CLONING CABLE

Used for data cloning between transceivers.

## **OPC-478/OPC-478UC** CLONING CABLE

Used for data cloning between transceiver and PC with CS-80/880 (free download software).

OPC-478 : RS-232C type

OPC-478UC : USB type

## **OPC-589** MIC ADAPTOR CABLE

Allows you to connect a regular 8-pin microphone.

## **OPC-1529R** DATA COMMUNICATION CABLE (RS-232C type)

Allows low-speed data communication in the DV mode and data cloning operation with CS-80/880 (free download software).

## **SP-10** EXTERNAL SPEAKERS

For all-round mobile operation. Cable length: 1.5 m; 4.9 ft<sup>†</sup>

## **MB-120** MOUNTING BASE

Mounts the remote controller on to variety of place in vehicle. Remote controller bracket is required for mounting.

<sup>†</sup>Approx.

## - 1 -

1200 bps packet operation .....	158
1750 Hz tone .....	26
9600 bps high speed packet operation .....	160

## - A -

About priority beep function .....	111
About the D-STAR system .....	29
About time-out timer function .....	29
Access repeater scan .....	48
Access repeater setting (R1 USE) .....	37
Accessing a repeater .....	23
Active band (ACTIVE) .....	129
Adjusting the transmitting signal output from the TNC .....	161
Alarm area 1 .....	84
Alarm area 2 .....	85
All reset .....	154
Antenna connector .....	V
Antenna information .....	1
Antenna installation .....	V
Antenna location .....	V
Attenuator (AT-ATT) .....	127
Audio filter (AF-FIL) .....	132
Audio mute function .....	20
Auto dimmer (AT-DIM) .....	130
Auto gateway setting (GW SET) .....	136
Auto power OFF (AP OFF) .....	130, 157
Auto repeater (AUTORP) .....	28, 128
Auto reply (REPLY) .....	66, 134

Automatic reply function setting .....	66
Automatic transmission (DTMF memory) .....	143
Available characters .....	64, 94
Available DTCS codes .....	122, 148
Available tone frequencies .....	121, 148

## - B -

Band edge beep (EDGE B) .....	133
Band scan .....	102
Basic operation .....	11
Battery connection .....	VI
Beep output level (BEEPLV) .....	133
Break-in communication .....	68
Break-in function (BK) .....	137
Busy lockout (LK OUT) .....	128

## - C -

Call channel .....	13
Call channel watch .....	112
Call channel watch via the microphone .....	114
Call record channel .....	44
Call sign edit record (EDIT R) .....	135
Call sign programming .....	31
Calling a specific station (in the DR mode) .....	52
Calling a specific station (in the VFO) .....	57
Calling a specific station in another zone (Different zone call) .....	54, 63
Calling a specific station in the same area (Area call) .....	53, 59
Calling a specific station in the same zone (Zone call) .....	53, 61
Calling CQ (in the DR mode) .....	50

---

## INDEX

Calling CQ in another area (Different zone CQ).....	51	DATA speed (SPEED).....	130
Calling CQ in another area (Zone CQ).....	51	Data speed for packet operation.....	157
Calling CQ in another zone (Different zone CQ).....	51, 62	DC power supply connection.....	VI
Calling CQ in the same area (Area CQ).....	51, 58	Desired call record indication.....	44
Calling CQ in the same zone (Zone CQ).....	51, 60	Digital code (D CODE).....	122
Changing a repeater list (EDIT-L).....	40	Digital code setting.....	152
Clearing a DTMF memory.....	145	Digital mode operation.....	42
Clearing a repeater list (EDIT-L).....	41	Digital monitor (D MONI).....	134
Cloning between transceivers.....	155	Digital repeater setting (D RPT).....	134
Cloning error.....	156	Digital squelch.....	151
Cloning using personal computer.....	156	Direction indication example.....	79
Comment (COMMENT).....	141	Display color (COLOR).....	131
Confirming current call sign.....	43	Display dimmer (DIMMER).....	130
Confirming the setting (in the DR mode).....	55	Displaying direction and forward.....	78
Connecting to a DC power source.....	VI	DR (D-STAR Repeater) mode.....	13
Connecting to a DC power supply.....	VI	DR (D-STAR Repeater) mode operation.....	48
Connection (GPS receiver).....	73	DR mode operation flow chart.....	48
Connection for the Low-speed data communication.....	70	DR mode/VFO watch.....	115
Controller's attachment/detachment.....	IV	DTCS code (CODE).....	122
Copying memory/call contents.....	96	DTCS polarity (DTCS-P).....	122
Copying the call record contents into call sign memory.....	47	DTCS polarity setting.....	149
Copying the call sign.....	46	DTCS squelch (beep) operation.....	146
Copying the call sign memory contents.....	46	DTMF memory encoder.....	142
Current call sign setting.....	42	DTMF speed (DTMF-S).....	122, 145
Current repeater call sign programming.....	33	DTMF tones.....	26
		DUP.T mode items.....	121
		Duplex direction setting (DUP).....	38
		DV auto detect (DV DET).....	72, 135
		DV data TX (DATATX).....	134

Data cloning.....	155
DATA extension (DT EXT).....	140

DV mode operation ..... 42  
 DV mode programming ..... 29  
 DV SET mode items (DV SET) ..... 134

– E –

EMR communication ..... 67  
 EMR function (EMR) ..... 137  
 Entering MENU screen and operation ..... 116  
 Entering MENU screen via the microphone ..... 117  
 Erasing bank contents ..... 99  
 Explicit definitions ..... i

– F –

[F-1]/[F-2] key on the HM-133 ..... 153  
 Fan control (FAN) ..... 129  
 FCC information ..... iii  
 Features ..... i  
 Foreword ..... i  
 Frequency lock ..... 16  
 Frequency offset (OFFSET) ..... 27, 121  
 Frequency offset programming (OFF SET) ..... 38  
 Frequency programming (FREQ) ..... 37  
 Frequency range and offset direction ..... 25  
 Front panel ..... 2  
 Full scan ..... 102  
 Function display ..... 4  
 Function guide indicator ..... 6  
 Fuse replacement ..... 165

– G –

Gateway repeater call sign programming (GW CAL) ..... 36, 40  
 General (MENU screen) ..... 116  
 General (Repeater operation) ..... 22  
 General description ..... 87  
 GPS alarm setting ..... 81  
 GPS alarm setting in GPS memory channel ..... 82  
 GPS auto TX timer (GPS.ATX) ..... 142  
 GPS data addition ..... 80  
 GPS data out (GPS.OUT) ..... 138  
 GPS indication (INDIC) ..... 138  
 GPS memory clearing ..... 83  
 GPS message automatic transmission ..... 75  
 GPS message programming ..... 75  
 GPS mode items ..... 138  
 GPS operation ..... 73  
 GPS set (GPS.SET) ..... 138  
 GPS/GPS-A OPERATION ..... 73  
 GPS-A function ..... 86  
 GPS-A operation ..... 86  
 GPS-A set mode ..... 139  
 GPS-A symbol (SYMBOL) ..... 140  
 GPS-TX mode items (GPS-TX) ..... 138

– H –

How to use break-in? ..... 69

# INDEX

	<b>- I -</b>	
Important .....	i	
Installation .....	I	
Installation methods .....	I	
Items list .....	119	
	<b>- K -</b>	
Key-touch beep (KEY B) .....	133	
	<b>- L -</b>	
LCD contrast (CONT) .....	131	
Location .....	II	
Lock functions .....	16	
Low-speed data communication .....	70	
Low-speed data communication application setting .....	70	
Low-speed data communication operation .....	70	
	<b>- M -</b>	
Main unit .....	1	
Maintenance .....	164	
Manual transmission (DTMF) .....	144	
Memory bank link function (B-LINK) .....	124	
Memory bank scan .....	106	
Memory bank selection .....	93	
Memory bank setting .....	92	
Memory channel contents .....	87	
Memory channel programming .....	90	
Memory channel watch .....	112	
Memory channel watch via the microphone .....	114	
		Memory clearing .....
		Memory mode .....
		Memory scan .....
		Memory scan watch .....
		Memory scan watch via the microphone .....
		Memory/call channels .....
		MENU screen indication and arrangement .....
		MENU screen operation .....
		Message operation .....
		Message transmission .....
		Mic sens level (MIC-S) .....
		Mic UP/DN (MIC-UP/MIC-DN) .....
		Microphone (HM-133) .....
		Microphone connection .....
		Microphone keypad .....
		Microphone keypad lock .....
		Microphone keys .....
		Monitor function .....
		"MY" call sign programming .....
		<b>- N -</b>
		Name indication (NAME) .....
		New repeater list programming .....
		Noise filter (NOISE-F) .....
		<b>- O -</b>
		One-touch PTT function .....
		One-touch reply using the call record .....
		One-touch reply using the call record in the DR mode .....

Opening message (OPN.MSG) ..... 132  
 Operating frequency band selection ..... 11  
 Operating mode selection ..... 18  
 Optional microphone (HM-154) ..... 10  
 Options ..... 168  
 Other function in the DV mode ..... 72  
 Other functions ..... 153

– P –

Packet jack pin assignment ..... 158  
 Packet loss indication ..... 72  
 Packet operation ..... 157  
 Panel description ..... 1  
 Partial reset ..... 154  
 Position format (P FORM) ..... 138  
 Position indication ..... 76  
 Precaution — magnets ..... I  
 Precautions ..... ii  
 Preparation ..... 11  
 Priority watch (PRIO) ..... 111, 123  
 Priority watch operation ..... 112  
 Priority watch types ..... 111  
 Program scan link function (P-LINK) ..... 125  
 Program skip scan (P-SKIP) ..... 123  
 Programmed scan ..... 102  
 Programming a DTMF tone sequence ..... 142  
 Programming a memory channel via the microphone ..... 91  
 Programming memory bank name ..... 94  
 Programming memory channels ..... XI

Programming memory name ..... 94  
 Programming scan edges via the microphone ..... 104  
 Programming scan name ..... 94  
 PTT lock (PTT LK) ..... 127

– Q –

Quick reference guide ..... I

– R –

Received call sign ..... 44  
 Received GPS message indication ..... 76  
 Receiving ..... 17  
 Receiving a D-STAR repeater ..... 43  
 Remote installation — Controller ..... V  
 Remote installation — Main unit ..... II  
 Repeater call sign auto write (RPT W) ..... 135  
 Repeater call sign programming ..... 33  
 Repeater call sign programming (CALL S) ..... 35, 39  
 Repeater group programming (GROUP) ..... 36  
 Repeater list ..... 34  
 Repeater list contents ..... 34  
 Repeater list programming ..... 35  
 Repeater name programming (R-NAME) ..... 35, 39  
 Repeater operating flow chart ..... 22  
 Repeater operation ..... X, 22  
 Repeater operation in the VFO ..... 58  
 Repeater tone frequency (R TONE) ..... 121  
 Reverse DTCS squelch ..... 147  
 Reverse tone squelch ..... 147

---

## INDEX

RPT1/RPT2 call sign programming .....	33
RX call sign auto write (CALL W) .....	135
RX call sign display (RX CS) .....	136
RX message display (RX MSG) .....	136
RX message indication .....	66

### – S –

Saving own position data .....	78
Saving received position data .....	78
Scan edges programming .....	103
SCAN mode items .....	123
Scan name (SCAN N) .....	132
Scan operation .....	100
Scan pause timer (PAUSE) .....	109, 123
Scan resume condition .....	109
Scan resume timer (RESUME) .....	109, 123
Scan start/stop via the microphone .....	107
Scan stop beep (STOP B) .....	133
Scan types .....	100
Scroll speed (SCROLL) .....	136
Secondary function guides .....	6
Selecting a call channel .....	89
Selecting a memory channel .....	88
Selecting a call record via RX CAL screen .....	45
Selecting memory bank name indication .....	95
Selecting memory name indication .....	95
Selecting output power .....	18
Selecting the operating frequency band .....	VIII
Sending CQ (in the VFO) .....	56
Sentence formatter setting (GGA) .....	74, 139
Sentence formatter setting (GLL) .....	74, 139
Sentence formatter setting (GSA) .....	74, 139
Sentence formatter setting (GSV) .....	74, 139
Sentence formatter setting (RMC) .....	74, 139
Sentence formatter setting (VTG) .....	74, 139
Separation cable connection .....	IV
Set condition guide guides .....	6
SET mode — DISP items .....	130
SET mode — FUNC items .....	127
SET mode — SOUNDS items .....	132
Setting a memory channel .....	XI
Setting DTCS code .....	148
Setting duplex .....	X
Setting frequency .....	XI
Setting Pause timer via the microphone .....	110
Setting Resume timer via the microphone .....	110
Setting tone squelch frequency .....	147
Simplex operation in the VFO .....	56
Single body installation .....	I
Skip channel setting .....	108
Skip frequency setting .....	108
Skip setting (for Access repeater scan) .....	49
Specifications .....	166
Squelch attenuator .....	19
Squelch attenuator setting .....	19
Squelch delay timer (SQL-DL) .....	127
Standby beep (STBY B) .....	133
Station call sign programming .....	32



Storing the repeater list (ADD W) ..... 38  
 Subaudible tones (Encoder function) ..... 25  
 Supplied accessories ..... iii  
 System description (D-STAR) ..... 30

– T –

Time stamp (TIME) ..... 140  
 Time-out timer (TOT) ..... 128, 157  
 Tone scan ..... 150  
 Tone squelch (beep) operation ..... 146  
 Tone squelch and pocket beep ..... 146  
 Transferring bank contents ..... 99  
 Transmission condition setting (Low-speed data communication) .. 71  
 Transmitting ..... 17  
 Transmitting a DTMF code directly ..... 144  
 Transmitting a DTMF tone sequence ..... 143  
 Troubleshooting ..... 164  
 TSQL frequency (C TONE) ..... 121  
 Tune the frequency ..... IX  
 Tuning step selection ..... 15  
 Turning ON the transceiver ..... VIII  
 TX call sign display (TX CS) ..... 136  
 TX message programming ..... 64

– U –

Units (UNITS) ..... 138  
 Unproto Address (UNPROT) ..... 139  
 [UP]/[DN] key on a microphone ..... 153  
 UR and MY call signs setting ..... 152

“UR” call sign programming ..... 32  
 Using the [▲]/[▼] keys ..... 14  
 Using the [▲]/[▼] keys (Memory selection) ..... 88  
 Using the keypad ..... 15  
 Using the keypad (Memory selection) ..... 88  
 Using the mounting bracket ..... II  
 Using the tuning dial ..... 14  
 Using the tuning dial (Memory selection) ..... 88  
 UTC offset (UTC.OFF) ..... 138

– V –

VFO mode ..... 12  
 VFO scan watch ..... 113  
 VFO scan watch via the microphone ..... 114

– W –

Weather alert (WX-ALT) ..... 124  
 Weather alert function ..... 162  
 Weather channel ..... 13  
 Weather channel operation ..... 162  
 What is VFO? ..... 12  
 Writing a memory channel ..... XI

– Y –

Your first contact ..... VIII  
 Your own call sign programming ..... 31

---

MEMO



**Count on us!**

A-6728D-1EX-0a  
Printed in Japan  
© 2009 Icom Inc.

Printed on recycled paper with soy ink.

**Icom Inc.**  
1-1-32 Kamiminami, Hirano-ku, Osaka 547-0003 Japan